



In 1976 Counter-Form LLC. began operations, focusing on a single goal: To make the highest quality postform countertop in the industry at an affordable price, while providing its customers with the best in service. Today, although techniques and product lines have changed, our goal remains the same. Counter-Form offers unsurpassed experience, from our office staff to our fabricators. We offer quick lead times and the best in customer service. Discover why Counter-Form is an industry leader.

Counter-Form crafts a complete line of ready-to-cut laminate slabs, custom, and cut-to-size laminate countertops with all the colors and patterns available from Wilsonart®, Arborite®, Formica®, Pionite®, and Nevamar®. We stock over 250 of their best-sellers and offer many different edge profiles. Counter-Form can fabricate an almost infinite array of creative possibilities.

On the surface, laminate countertops all look pretty much the same. It's what's underneath that separates Counter-Form from the rest! Constructed from the highest quality western pine industrial board. With Counter-Form quality countertops, what you don't see makes all the difference!



COUNTER-FORM.COM

INDEX

CARE & MAINTENANCE / 3-4-5 RULE	3
ECO "D " EDGE / 180° EDGE	20
ECO MONARCH EDGE.....	27
ECO NO DRIP EDGE.....	30
ECO PREMIER EDGE	25
ECO REGENT EDGE	26
ECO ROMAN EDGE.....	24
ECONO EDGE (ECONO TOP).....	18
EDGE PROFILES.....	17
FINISH CODES.....	8
LAMINATE SHEETS.....	32
ORDER FORM.....	6
PRE-ORDER GUIDELINES.....	8
SAMPLE BOARDS.....	10
SIDE SPLASH DIAGRAMS	34
SPLASHES / MISCELLANEOUS	33
STOCK COLOR LIST	9
TERMS & CONDITIONS.....	4
UPCHARGES PER LINEAL FOOT.....	12
WARRANTY.....	2
WEBSITE.....	5

THE ESSENTIAL PROGRAM FROM COUNTER-FORM

Available exclusively on Slab/Blank orders.
ECO edges do not include backer on the front
build down and features a particle board scribe.
Limited to the edge profiles featured in this book.
Minimum orders do apply.



MANUFACTURER'S WARRANTY

Any of our products found to have a manufacturing defect within one year from purchase will be handled in the following manner:

1. We will ship, to our dealers "point of delivery", all materials supplied by us.
2. In as much as Counter-Form LLC has no control over installation or fabrication on the job, **no warranty is expressed or implied in reference to installation, plumbing or labor of any manner.**
3. At our option, before shipping materials, we may request to inspect the job.
4. All materials coming off the job become property of Counter-Form LLC.
5. Credit will be issued when countertops are returned to Counter-Form LLC and we have determined that it is a manufacturing defect.

IMPORTANT: BEFORE INSTALLING TOPS

- **Water damage voids the warranty! Installer/plumber must seal all raw exposed particle board.**
- **WARRANTY covers replacement of tops ONLY. No labor costs.**
- CHECK CONDITION OF TOPS BEFORE INSTALLING. If your tops came with poly on them, take the poly off and inspect tops before assembling.
- DRY FIT COUNTERTOPS and if there are any issues, DO NOT GLUE and ASSEMBLE.
- TOPS SHOULD BE SET ON LEVEL CABINETS AND ALLOWED TO ACCLIMATE. If tops were subject to high humidity, they may need more time to acclimate to the surrounding.
- MAKE SURE MITER JOINTS ARE CLEAN. Using a paint brush, COMPLETELY coat each raw edge of miter joint with waterproof glue.
- Quickly align tops and tighten miter bolts. Open times vary depending on glue manufacture. Splined Miters help with alignment but all miters have to be adjusted. While tightening each miter bolt, a small block of wood can be used to "TAP" on the deck of the countertop so laminate does not get damaged. Working from front to back, line up tops so laminate is flush, then tighten bolt, repeating for each bolt.
- Clean off excess glue with a damp cloth.
- Warranty is void if joints are not properly assembled.
- Color matched seamfill is available for final touch-up.
- TOPS ABOVE DISHWASHERS SHOULD BE SEALED. The area above the dishwasher is exposed to moisture. Vents on top of door can cause damage quickly.
- STOVES and COOKTOPS MUST BE SET AT A HEIGHT ABOVE THE COUNTERTOP. This will prevent end caps from high heat which could cause delamination.
- ALL FAUCET HOLES CUT NEED TO BE SEALED. Use a good silicone to seal all raw particle board exposed to prevent water damage.
- DO NOT EXPOSE MITER SEAMS TO STANDING WATER OR SET COFFEE POTS OVER SEAM. WATER DAMAGE IS PERMANENT AND IS NOT A WARRANTY ISSUE.

CARE & MAINTENANCE

1. Do not expose miter seams to standing water or set coffee pots over seam. Water damage is permanent and is not a warranty issue.
2. STOVES and COOK TOPS must be set at a height ABOVE the top of your counter top. This will prevent end caps from excessive heat that could cause them to release.
Tops above dishwashers should have area above dishwasher sealed to prevent moisture damage. Vents on top of door can cause damage quickly.
3. FAUCET HOLES - All holes drilled through the top MUST be sealed with silicone. All raw particle board must be sealed to prevent water damage.
4. Use a damp cloth or sponge with a mild NON ABRASIVE detergent for cleaning. Then rinse thoroughly and wipe dry with a clean soft cloth.
5. For tougher stains, a SOFT BRISTLED brush may be used. Abrasive cleaners WILL cause premature wear.
6. ALWAYS use a cutting board when slicing to avoid cuts & scratches. Any sharp object can scratch the surface.
7. ALWAYS use hot pads to protect the surface from hot pans, as enough heat will damage the surface.
8. NEVER SLIDE “stonewear” across the surface, as it is very abrasive, and will cause scratches and premature wear.
9. Polishes such as “Hopes Counter Top Polish” can help by reducing friction.
10. Certain household chemicals WILL DAMAGE the surface, including:

Toilet Bowl Cleaners
Drain Cleaners

White Vinegar
Hydrogen Peroxide

Oven Cleaners
Stain & Rust Removers

Bleach
Anti-Bacterial Formulas

If any of these items come in contact with the surface, IMMEDIATELY clean that area very thoroughly and wipe dry with a clean soft cloth. Following these guidelines, your countertop should remain looking new for many years.

Special Tip

Always rinse laminate after cleaning! Failure to rinse after cleaning is the single greatest cause of damage to a laminate surface. If even a small amount of cleaning solution remains on the surface, moisture from cups or dishes can reactivate it and result in permanently-etched scars. Always rinse thoroughly with clean water and dry with a soft, clean cloth.

3-4-5 RULE

Use this rule to check for square (90°) corner.

Corner is square if 3-4-5 rule works.

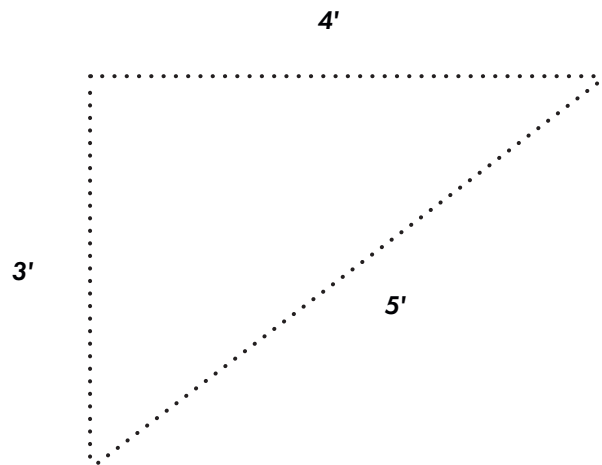



Counter-Form, LLC makes every effort to ensure you receive your materials as ordered. We are committed to providing excellence in craftsmanship and service. Please read and review the following terms and conditions of your purchase:

MEASUREMENTS:

The buyer is responsible for the accuracy of all measurements supplied to Counter-Form. Counter-Form accepts no responsibility or liability for measurement errors. The customer is responsible for the final design approval.

DELIVERY LEAD TIMES:

All delivery times are estimates. Custom edge and non-stock colors may have extended lead times.

INSPECTIONS

Upon receipt of delivery, materials should be inspected for damage. Claims need to be notated on delivery receipt or reported to the Counter-Form Customer Service Department immediately. If a return is required, contact the Counter-Form Customer Service Department to arrange for return authorization.

RETURNS

To be eligible for a return or exchange, begin by contacting your customer service representative. The product must be in its original condition and damage-free, all returns will be inspected prior to merchandise credit. Custom ordered products, and Special Orders may not be returned. NO Returns on non-stock colors. STOCK colors subject to a 20% restocking charge. Cut or damaged pieces cannot be accepted.

CHANGE ORDERS

Contact your Counter-Form customer service representative for all order changes. Orders prior to entering production can be changed at no charge. For orders that are in production (shop floor), changes may be limited and will have a \$25 fee applied.

NON STOCK LAMINATE

Additional lead-times may be incurred depending on supplier availability. Estimated delivery dates are supplied with the order acknowledgment. Laminates not stocked at Counter-Form may need to be purchased in full sheets, a line item charge for balance of sheet will be noted on the quote/acknowledgment.

YOU CAN FIND IT ON THE COUNTER-FORM.COM WEBSITE

We encourage you to check out the Counter-Form Website. We have it all - resources for your customers to help them select the perfect pattern, all the details including specifications and technical content that you require, and information to learn more about our capabilities and services that are available. [Explore the Possibilities at Counter-Form.com.](#)

Would you like to link our product section to your website? Let your customers select their perfect pattern before they visit your store or shop. Contact our Customer Service or your sales representative to learn more!

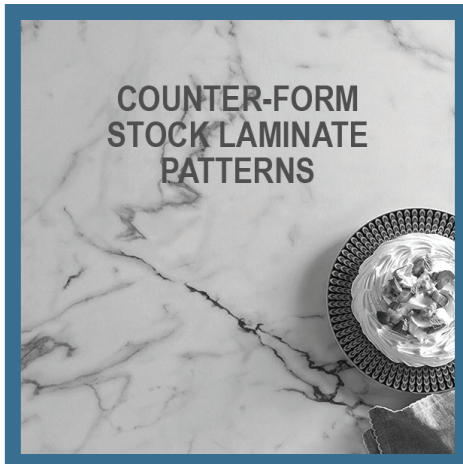

A COMPLETE GUIDE TO OUR STOCK PATTERNS

- A COLOR PHOTO GALLERY OF OUR STOCK PATTERNS
- FULL SHEET VIEWS AND APPLICATION PHOTOS
- VISUALIZERS AND DOWNLOADS
- EDGE PROFILE CHOICES & EXAMPLES
- FINISH OPTIONS
- SPECIFICATIONS & REFERENCE TOOLS
- NEW & SPECIAL FEATURED PATTERNS
- DOWNLOADABLE INTERACTIVE PDF FORMS

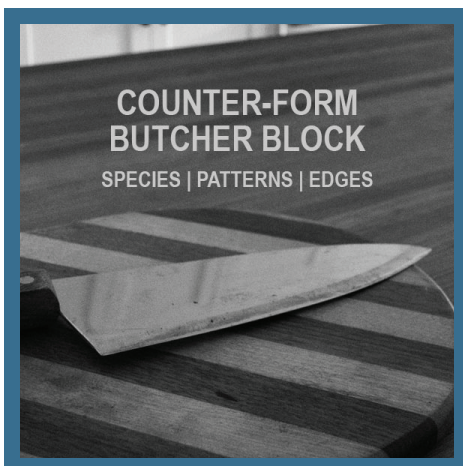

BUTCHER BLOCK SPECIES GUIDE

- A COLOR PHOTO GALLERY OF OUR SINGLE SPECIES AND MIXED SPECIES COLLECTIONS
- APPLICATION PHOTOS
- PATTERN OPTIONS
- EDGES & FINISHES
- SPECIALTY OPTIONS
- CARE INSTRUCTIONS
- DOWNLOADABLE INTERACTIVE PDF ORDER FORMS



KARRAN UNDERMOUNT SINK GUIDE

- A COLOR PHOTO GALLERY OF OUR EDGE, QUARTZ & ACRYLIC SERIES
- LAYOUTS & DIMENSIONS
- ACCESSORY GUIDE
- CARE INSTRUCTIONS

Explore the Possibilities at
[Counter-Form.com](#)



NAME

page ____ of ____

PURCHASE #

DATE ORDERED

DATE REQUIRED

USE A SEPARATE ORDER FORM FOR NON-STOCK COLORS

Color:		JOB#
QUANTITY	DESCRIPTION	

Color:		JOB#
QUANTITY	DESCRIPTION	

Color:		JOB#
QUANTITY	DESCRIPTION	

Color:		JOB#
QUANTITY	DESCRIPTION	

Color:		JOB#
QUANTITY	DESCRIPTION	

Color:		JOB#
QUANTITY	DESCRIPTION	

Email directly to your CSR or send to orders@counter-form.com. Questions? Call our office at (715) 384-2131



PIONITE FINISH CODES

AB = Aged Bark	MG = Medium Gloss
AS = Aegis Secure	MZ = Metalz
AW = Ashwood	NS = Natural Stone
BB = Barnboard	NW = Natural Wood
CR = Crystal	PV = Polished Velvet
EV = Evolution	SD = Suede
FL = Fineline	SL = Slate
GL = Gloss	SM = Super Matte
GR = Granite	SX = StoneX
GV = Groovy	TL = Timberline
HX = Hex	TW = Tactile Weave
LR = Soft Leather	VE = Velvet
LZ = LineZ	WE = Wood Essence

FORMICA FINISH CODES

11 = Satin Touch	MC = MicroDot
26 = Oiled Wood	ML = Monolith
34 = Scovato	NG = Natural Grain
42 = Crystal	NT = Naturelle
43 = Artisan	PG = Pure Grain
46 = Etchings	PX = Plex
58 = Matte	RD = Radiance
90 = Gloss	SP = Sculpted
BH = Brush	WR = Woodbrush

ARBORITE FINISH CODES

AW = Artisan Walnut	LE = Legno
BC = Breccia	LM = Luminous
BT = Basalt	LQ = Laqwood
CA = Cashmere	MX = Metalux
CW = Casual Wood	RM = Refined Matte
DI = Diamond	SR = Structured
EV = Evergrain	UL = Ultra Smooth
FP = French Polish	VL = Velvatex
GL = Gloss	VT = Vista
IM = Impression	

Special Order - laminate available in limited sizes, excess/balance of laminate pieces may need to be purchased. Allow additional lead times on non-stock colors and special order laminates. When ordering, please reference the laminate NUMBER, not the name.

WILSONART FINISH CODES

01 = Gloss	35 = Mirage HD
05 = Timbergrain	38 = Fine Velvet Textured
07 = Textured Gloss	52 = Quarry
12 = Soft Grain	55 = Glaze HD
15 = Fieldstone	57 = Aligned Oak
16 = Casual Rustic	60 = Matte
18 = Linearity	67 = Aligned Walnut
19 = Leno Weave	78 = FineGrain
21 = Soft Silk	79 = Ridgewood
22 = Antique	K = AEON Finish
28 = Gloss Line	

NEVAMAR FINISH CODES

AB = Aged Bark	MG = Medium Gloss
AS = Aegis Secure	MZ = Metalz
AW = Ashwood	NS = Natural Stone
BB = Barnboard	NW = Natural Wood
CR = Crystal	PV = Polished Velvet
EV = Evolution	SD = Suede
FL = Fineline	SL = Slate
GL = Gloss	SM = Super Matte
GR = Granite	SX = StoneX
GV = Groovy	T = ARP (Armored Protection)
HX = Hex	TL = Timberline
LR = Soft Leather	TW = Tactile Weave
LZ = LineZ	VE = Velvet
	WE = Wood Essence

PRE-ORDER GUIDELINES

- Steps taken by Counter-Form for pre orders:
- Orders are entered into our system with sizes that are provided.
- Laminate is ordered to accommodate that size top. (Example: Kitchen top size is 90", we order 30"x96" laminate, if the top were to change to 99", we could not use the 96" pc. and would reorder 120" pc. You would be responsible for the 96" pc.)
- Received laminate is set aside for that order until the customer needs it.
- When final sizes are received, tops will be put into production.
- Pre-orders will be accepted one month in advance. All pre-orders must have a P.O. number and a contact name. Any pre-orders that change are subject to extra laminate charges and the balance of laminate will be delivered with the tops.
- If final orders are not received within one month of pre-order, laminate will be delivered and invoiced to the customer.
- NOTE: If Applied Edge sticks are pre-ordered, the color cannot be changed. Counter-Form does not make the sticks.

PIONITE

GROUP	GROUP	GROUP	GROUP	GROUP	GROUP
AE021SD 0	AG361SD 0	AT191SD 0	MG115GR 2	MG190EV 3	MT330SD 0
AG081SM 2	AG381SD 0	AW141SD 0	MG120SX 2	MG200PV 2	MW570GR 2
AG130SM 2	AT161SD 0	ME100SD 0	MG145SD 0	MR120SX 2	MW575SD 0
AG180SD 0	AT181SD 0	MG071SD 0	MG180SD 0	MT250SD 0	PFA51SD 0

**FIND MORE
RESOURCES
ONLINE**

COUNTER-FORM.COM

WILSONART

GROUP	GROUP	GROUP	GROUP	GROUP	GROUP	GROUP	GROUP	GROUP
D354-60 0	1867K-55 4	1878K-35 4	1891K-55 4	4726K-52 3	4907-38 0	4954K-22 3	5005-38 0	5039K-15 4
1595-60 1	1870K-55 4	1879K-35 4	2932-60 0	4762-60 0	4922-52 3	4955K-22 3	5008K-07 3	5042K-07 3
1815K-35 4	1871K-35 4	1880K-35 4	4142-60 0	4835-38 0	4924-38 0	4957K-22 3	5009-60 0	5044K-60 0
1818K-35 4	1872K-35 4	1881K-35 4	4143-60 0	4841-60 0	4925K-07 3	4979K-07 3	5010K-07 3	5045K-15 4
1820K-35 4	1874K-35 4	1882K-35 4	4168-60 0	4842-60 0	4926K-07 3	4981-38 0	5011K-22 3	5062-38 0
1832K-35 4	1874K-52 3	1883K-35 4	4170-60 0	4878-38 0	4929-38 0	4987K-07 3	5025K-22 3	5063K-22 3
1842K-35 4	1875K-35 4	1884K-35 4	4551K-01 2	4882-38 1	4931-38 0	4995-60 0	5026K-07 3	5064-60 0
1849K-35 4	1875K-52 3	1885K-07 3	4588K-07 3	4886-38 0	4932-38 0	4988K-07 3	5027K-07 3	5067K-15 4
1850K-35 4	1876K-35 4	1886K-07 3	4595K-52 3	4888-38 1	4944-38 0	4998K-22 3	5028K-07 3	
1858K-55 4	1876K-52 3	1887K-22 3	4674-60 0	4904-38 0	4952K-22 3	5000K-22 3	5029K-22 3	
1863K-55 4	1877K-35 4	1888K-22 3	4724K-52 3	4905-38 0	4952K-52 3	5003-38 0	5031K-07 3	
1864K-55 4	1877K-52 3	1890K-22 3	4725K-52 3	4905-52 3	4953K-22 3	5004-38 0	5037K-38 0	

FORMICA

GROUP	GROUP	GROUP	GROUP	GROUP	GROUP	GROUP	GROUP	GROUP
271-46 3	3466-RD 4	3546-46 4	3702-34 4	6227-46 3	6697-58 0	7408-43 0	8831-58 0	9476-46 3
909-58 1	3476-46 4	3546-ML 4	3703-11 4	6280-46 3	7022-58 0	7409-43 0	9284-RD 4	9476-58 0
949-58 0	3496-46 3	3547-RD 4	3706-ML 3	6280-58 0	7264-58 0	7494-58 0	9302-34 4	9497-58 0
3420-46 4	3496-58 0	3690-34 3	3712-NG 3	6314-58 0	7267-58 0	7500-58 0	9303-RD 4	9511-34 3
3422-RD 4	3517-46 3	3690-58 1	5014-11 4	6319-RD 4	7402-11 4	7732-46 3	9306-34 3	9529-58 0
3450-RD 3	3518-46 3	3692-46 3	5018-11 4	6320-46 4	7403-58 4	7732-58 0	9306-58 0	9534-34 4
3456-58 0	3522-46 3	3692-58 0	5019-34 3	6696-46 3	7404-11 4	7734-46 3	9308-46 3	9536-34 4
3460-11 4	3522-58 0	3700-11 4	6226-46 3	6696-58 0	7405-34 4	7734-58 0	9309-46 3	9537-34 4
3460-46 4	3526-58 0	3701-11 4	6226-58 0	6697-46 3	7407-58 0	8830-58 0	9309-58 0	

NEVAMAR

GROUP	GROUP	GROUP	GROUP
GR4001T 0	MG0930EV3	MW5450VE 2	RK6003T 0
LN6002T 0	MT4050EV 3	PO7001T 0	RK7002T 0
ME0600SD0	MW5350VE 2	RK2001T 0	SL6003T 0

ARBORITE

GROUP	GROUP	GROUP	GROUP	GROUP	GROUP	GROUP
P127CA 0	P394CA 0	P1000V L 3	P1007IM 3	P1013UL 3	P1018VL 3	P1023BT 3
P345CA 0	P395CA 0	P1002VT 3	P1008VL 3	P1014UL 3	P1019BT 3	P1024VL 3
P346CA 0	P398CA 0	P1004IM 3	P1009VL 3	P1015UL 3	P1020BT 3	
P392CA 0	P407CA 0	P1005VT 3	P1010IM 3	P1016UL 3	P1021BT 3	
P393CA 0	P421CA 0	P1006VT 3	P1011IM 3	P1017VL 3	P1022VL 3	



STOCK SAMPLE BOARD 1

271-46 BLACKSTONE ETCHING	909-58 BLACK	949-58 WHITE	3420-46 SANTA DOLCE VITA ETCHING	3422-RD CREMA MASCARELLO RADIANCE	3450-RD MINERAL JET RADIANCE	3456-58 MOCHA TRAVERTINE	3460-11 CALACATTA MARBLE SATIN TOUCH	3460-46 CALACATTA MARBLE ETCHING	3466-RD ANTIQUE MASCARELLO RADIANCE	3476-46 JET SEQUOIA	3496-46 BELMONTE GRANITE ETCHING
3496-58 BELMONTE GRANITE	3517-46 SAND CRYSTALL ETCHING	3518-46 FLINT ETCHING	3522-46 PERLATO GRANITE ETCHING	3522-58 PERLATO GRANITE	3526-58 TRAVERTINE	3546-46 RIVER GOLD ETCHING	3546-ML RIVER GOLD MONOLITH	3547-RD LAPIDUS BROWN RADIANCE	3690-34 BASALT SLATE SCOVATO	3690-58 BASALT SLATE	3692-46 LABRADOR GRANITE ETCHING
3692-58 LABRADOR GRANITE	3700-11 WHITE ALABASTER	3701-11 MANHATTAN MARBLE	3702-34 MEDITERRA- NEAN MARBLE	3703-11 WOODLAND MARBLE	3706-ML PATINE CONCRETE	3712-NG WALNUT BUTCHERBLOCK	5014-11 WHITE PAINTED MARBLE	5018-11 CALACATTA CAVA	5019-34 BLACK BARDIGLIO	6226-46 IVORY KASHMIRE ETCHING	6226-58 IVORY KASHMIRE
6227-46 AMBER KASHMIRE ETCHING	6280-46 MIDNIGHT STONE ETCHING	6280-58 MIDNIGHT STONE	6314-58 NEO CLOUD	6319-RD CAFÉ AZUL	6320-46 BLACK FUSION	6696-46 CARRARA BIANCO ETCHING	6696-58 CARRARA BIANCO	6697-46 ARGENTO ROMANO ETCHING	6697-58 ARGENTO ROMANO MATTE	7022-58 NATURAL CANVAS	7264-58 LIME STONE
7267-58 CONCRETE STONE	7402-11 PIETRA GRAFITE	7403-58 NERO MARQUINA	7404-11 NEOPOLITAN STONE	7405-34 ISTANBUL MARBLE SCOVATO	7407-58 MARMARA GRAY	7408-43 ICE ONYX ARTISIAN	7409-43 GRAY ONYX ARTISAN	7494-58 CARRARA ENVISION	7500-58 NOIR ENVISION	7732-46 BUTTERUM GRANITE ETCHING	7732-58 BUTTERUM GRANITE
7734-46 JAMOCHA GRANITE ETCHING	7734-58 JAMOCHA GRANITE	8830-58 ELEMENTAL CONCRETE	8831-58 ELEMENTAL STONE	9284-RD CLASSIC CRYSTAL GRANITE	9302-34 FANTASY MARBLE	9303-RD AZUL ARAN	9306-34 WHITE BARDIGLIO SCOVATO	9306-58 WHITE BARDIGLIO	9308-46 GERIBA GRAY	9309-46 STAR DUNE ETCHING	9309-58 STAR DUNE
9476-46 WHITE ICE GRANITE ETCHING	9476-58 WHITE ICE GRANITE MATTE	9497-58 SILVER QUARTZITE	9511-34 LAYERED SAND	9529-58 SEA SALT	9534-34 SEA PEARL	9536-34 QUARTZITE BIANCO	9537-34 STORMY NIGHT GRANITE				
AG381SD MINERAL TALC	AT161SD ROCKY MOUNTAIN HIGH	AT181SD AGATHA SUEDE	AT191SD VIOLA SUEDE	AE021SD GRAPHITE SPEKTRUM	AG081SM SUGAR PIE	AG130SM COOKIES & CREAM	AG180SD METEORIC METALLO	AG361SD GRAPHITE TALC	AW141SD ROCK OF AGES	ME100SD FADED MEMORIES	MG071SD BERNARD SUEDE
MG115GR MOON DUST GRANITE	MG120SX HAROLD STONE X	MG145SD SLATE IMPERIALE MARBLE	MG180SD GALACTIC DUST	MG190EV RICE LAKE	MG200PV CRESCENT PORTICO	MR120SX LOUISE STONE X	MT250SD MAN ON THE MOON	MT330SD CITY OF LIGHTS	MW570GR POLAR CAP GRANITE	MW575SD CHALK IMPERIALE MARBLE	PFAS1SD GRIDLOCK IN L.A.
GR4001 T MADURA GOLD GRANITE	LN6002 T KOPI SUSU	ME0600SD ESTASI	MG0930EV GRIGIO IMPERIALE MARBLE	MT4050EV TAUPE IMPERIALE MARBLE	MW5350VE RINNOVATO MARBLE	MW5450VE SPERANZA	PO7001 T PARIS WHITE POTTERWARE	RK2001 T CLASSIC ROCK	RK6003 T VERDICTS IN	RK7002 T VETO PROOF	SL6003 T RARE EARTH SLATE

STOCK SAMPLE BOARD 2

D354-60 DESIGNER WHITE	1595-60 BLACK	1815K-35 DEEPSTAR AGATE	1818K-35 DEEPSTAR SLATE	1820K-35 BELLA NOCHE	1832K-35 RIVER GEMSTONE	1842K-35 CANYON PASSAGE	1849K-35 LUNA FROST	1850K-35 LUNA WINTER	1858K-55 SILVER TRAVERTINE	1863K-55 BAINBROOK GREY	1864K-55 SALENTINA NERO
1867K-55 PERLA PIAZZA	1870K-55 COSMOS GRANITE	1871K-35 GOLDEN ROMANO	1872K-35 BIANCO ROMANO	1874K-35 WINTER CARNIVAL	1874K-52 WINTER CARNIVAL QUARRY	1875K-35 SUMMER CARNIVAL	1875K-52 SUMMER CARNIVAL QUARRY	1876K-35 SPRING CARNIVAL	1876K-52 SPRING CARNIVAL QUARRY	1877K-35 AUTUMN CARNIVAL	1877K-52 AUTUMN CARNIVAL QUARRY
1878K-35 GRANITO AMARELO	1879K-35 TRINIDAD LAPIDUS	1880K-35 MAGNATA	1881K-35 CIPOLLINO BIANCO	1882K-35 CIPOLLINO GRIGIO	1883K-35 FRANCESCA	1884K-35 CIPOLLINO CON PANNA	1885K-07 MARMO BIANCO	1886K-07 COTE D'AZUR	1887K-22 BENJAMIN GREY	1888K-22 HEBRON WHITE	1890K-22 SERRANIA
1891K-55 LARIO	2932-60 ALMOND LEATHER	4142-60 GREY GLACE	4143-60 NEUTRAL GLACE	4168-60 GREY PAMPAS	4170-60 BEIGE PAMPAS	4551K-01 BLACKSTAR GRANITE	4588K-07 KALAHARI TOPAZ	4595K-52 BAHIA GRANITE QUARRY	4674-60 EVENING TIGRIS	4724K-52 MILANO AMBER QUARRY	4725K-52 MILANO BROWN QUARRY
4726K-52 MILANO QUARTZ QUARRY	4762-60 MYSTIQUE DAWN	4835-38 TUMBLER ROCA	4841-60 DESERT ZEPHYR	4842-60 CANYON ZEPHYR	4878-38 PEWTER MESH	4882- 38 OILED SOAPSTONE	4886-38 PEARL SOAPSTONE	4888-38 RUSTIC SLATE	4904-38 DESERT SPRINGS	4905-38 SPICEWOOD SPRINGS	4905-52 SPICEWOOD SPRINGS QUARRY
4907-38 DEEP SPRINGS	4922-52 MADURA PEARL	4924-38 WHITE CARRARA	4925K-07 CALCUTTA MARBLE	4926K-07 BLACK ALICANTE	4929-38 BORDEAUX JUPARANA	4931-38 WHITE JUPARANA	4932-38 GOLDEN JUPARANA	4944-38 CASUAL LINEN	4952K-22 TYPHOON ICE ANTIQUE	4952K-52 TYPHOON ICE QUARRY	4953K-22 TYPHOON GOLD ANTIQUE
4954K-22 ITALIAN WHITE di PESCO ANTIQUÉ	4955K-22 CAFÉ di PESCO ANTIQUÉ	4957K-22 MOCHA FANTASTICO ANTIQUÉ	4979K-07 INK VESTA	4981-38 CALACATTA ORO	4987K-07 LECHE VESTA	4988K-07 MERCURY VESTA	4995-60 FORGED STEEL	4998K-22 ANDORRA SHADOW ANTIQUÉ	5000K-22 TOFFEE di PESCO ANTIQUÉ	5003-38 WHITE CASCADE	5004-38 DUSK CASCADE
5005-38 SIERRA CASCADE	5008K-07 PRALINE ANTICO	5009-60 PEBBLE PIAZZA	5010K-07 DRAMA MARBLE	5011K-22 POTTERS CLAY ANTIQUÉ	5025K-22 GLACIER QUARTZITE	5026K-07 BRAZILLIAN GREY	5027K-07 ARENITE CREAM	5028K-07 SOMBRA	5029K-22 OURO BRANCO	5031K-07 QUARTZ FROST	5037-38 ANZIO MARBLE
5039-15 BELLO ROMANO	5042-07 CALCATTI LINCOLN	5044-60 BEACHWALK	5045-15 ICE MIST	5062-38 BORGHINI MARBLE	5063K-22 PIETRA VIVA	5064-60 ROCA BASCO	5067K-15 ALUMA MARBLE				
P-127CA CONCRETE GREY	P-345CA INUKSHUK TAUPE	P-346CA INUKSHUK CARBON	P-392CA URBAN DAY	P-393CA URBAN NIGHT	P-394CA ARCTIC SNOW	P-395CA ARCTIC ICE	P-398CA YUKON RIVERBED	P-407CA MONOLITH	P-421CA ARCTIC SPIRIT	P-1000 VL ARABESCATO MARBLE	P-1002 VT SANTA CECILIA
P-1004 IM ROMAN TRAVERTINE	P-1005 VT TYPHOON BORDEAUX CRÈME	P-1006 VT TYPHOON BORDEAUX GREIGE	P-1007 IM CINDER SLATE	P-1008 VL SAINT LAURENT MARBLE	P-1009 VL MONT BLANC	P-1010 IM CITYSCAPE LOFT	P-1011 IM INDUSTRIAL LOFT	P-1013 UL NUVOLATO MARBLE	P-1014 UL TERRAZZO GRANDE	P-1015 UL CARRARA VENATO	P-1016 UL VERSAILLES MARBLE
P-1017 VL BAROQUE SOAPSTONE	P-1018 VL DREAMCATCHER	P-1019 BT ARIA QUARTZITE	P-1020 BT NUAGE QUARTZITE	P-1021 BT PERLA QUARTZITE	P-1022 VL BIANCO STATUARIO	P-1023 BT CHÂTEAU	P-1024 VL NUVOLATO CREMA				



MANY NON-STOCK COLORS ARE AVAILABLE IN LIMITED SIZES, BALANCE OF LAMINATE MAY NEED TO BE PURCHASED.

*ALLOW ADDITIONAL LEAD TIME ON NON-STOCK COLORS. NOT ALL COLORS/FINISHES MAY BE LISTED.

PIONITE

GROUP	GROUP	GROUP	GROUP	GROUP	GROUP	GROUP	GROUP
AB221SD 1	AP365SD 1	AW300SD 1	MT440SD 1	SQ312SD 1	WC115SD 1	WT741SD 1	WY160SD 1
AB300SD 1	AR250SD 1	AW700SD 1	MT500SD 1	SP401SD 1	WC210PV 2	WT790BB 2	WY160TL 2
AB300FL 2	AT106SD 1	AW785SD 1	MW550SD 1	SP414SD 1	WC230PV 2	WT790SD 1	WY351PV 2
AB400SD 1	AT106SD 1	AW871SD 1	MW570GR 2	SR505SD 1	WC331PV 2	WT850SD 1	WZ150SD 1
AE011CR 2	AT109SD 1	AY120SD 1	MW570SL 2	SR520SD 1	WC411SD 1	WT860SD 1	WZ160WE 2
AE021SD 0	AT161SD 0	AY135SD 1	MW575SD 0	SR525FL 2	WC421SD 1	WT870SD 1	WZ460WE 2
AE060SD 1	AT181SD 0	AY160SD 1	PFA42SD 1	SR525SD 1	WC431PV 2	WT870TL 2	
AE100PV 2	AT191SD 0	HP336SD 1	PFA48SD 1	SR537FL 2	WC521SD 1	WT880SD 1	
AG041SX 2	AT231SD 2	HP359PV 2	PFA51SD 0	SR537SD 1	WC562WE 2	WW011AB 2	
AG021SD 1	AT301SD 1	HP689SD 1	PFA60SD 1	ST604SD 1	WE261SD 1	WW011SD 1	
AG031SD 1	AT371SD 1	ME011GL 2	SBO06SD 2	ST606SD 1	WE261SM 2	WW050SD 1	
AG041SX 2	AT435TW 2	ME051SD 1	SBO07SD 1	ST655SD 1	WE360SD 1	WW050TL 2	
AG071SD 1	AT440SD 1	ME100SD 0	SBO09SD 1	SV709SD 1	WF131SD 1	WW075SD 1	
AG081SM 2	AT650SD 1	MG071GR 2	SBO27GL 2	SV713SD 1	WF181SD 1	WW120WE 2	
AG130SM 2	AT660SD 1	MG071SD 0	SBO27SD 1	SV750GL 2	WH110SD 1	WW160FL 2	
AG180SD 0	AT680SD 1	MG115GR 2	SBO40SD 1	SV750SD 1	WM115SD 1	WW160SD 1	
AG361SD 0	AT710SD 1	MG115SX 2	SE101AW 2	SW803SD 1	WM221SD 1	WW185SD 1	
AG381SD 0	AT970LR 2	MG120SX 2	SE101CR 2	SW806AW 2	WM791SD 1	WW561SD 1	
AG371SD 1	AT965SD 1	MG130SX 2	SE101SD 1	SW806SD 1	WM951SD 1	WW601SD 1	
AG415SD 1	AT981SD 1	MG145SD 0	SG203SD 1	SW811SD 1	WO095SD 1	WW971SD 1	
AG471SD 1	AT988SD 1	MG160SL 2	SG204SD 1	SW813SD 1	WO581SD 1	WX031SD 1	
AG500LR 2	AT991SD 1	MG170SL 2	SG208SD 1	SW826GL 2	WO680LZ 2	WX041SD 1	
AG561SD 1	AV208SD 1	MG180SD 0	SG210SD 1	SW826SD 1	WO862SD 1	WX110SD 1	
AG601SD 1	AV250SD 1	MG190EV 3	SG211SD 1	SW836SD 1	WO891SD 1	WX170SD 1	
AG611SD 1	AV674SD 1	MG200PV 2	SG213SD 1	SY913SD 1	WO951SD 1	WX230SD 1	
AG640SD 1	AV751SD 1	MR120SX 2	SG214SD 1	SY914SD 1	WP110SD 1	WX421PV 2	
AG730SD 1	AV781SD 1	MR125SX 2	SG224SD 1	WA001SD 1	WP115SD 1	WX421SD 1	
AG740TW 2	AV830SD 1	MR130SD 1	SG228SD 1	WA030SD 1	WP120SD 1	WX440SD 1	
AG750SD 1	AV971SD 1	MT250SD 0	SG240SD 1	WA030SM 2	WP125SD 1	WX600SD 1	
AG801SD 1	AV999SD 1	MT310GR 2	SG241SD 1	WA090SD 1	WP130SD 1	WX800SD 1	
AP280SD 1	AW141SD 0	MT330SD 0	SG246SD 1	WA110SD 1	WP140SD 1	WY031SD 1	
AP290SD 1	AW200SD 1	MT390SX 2	SG254SD 1	WA120SD 1	WP500LZ 2	WY131SD 1	

FINISHES

AB = Aged Bark	EV = Evolution	HX = Hex	NS = Natural Stone	SM = Super Matte
AS = Aegis Secure	FL = Finline	LR = Soft Leather	NW = Natural Wood	SX = StoneX
AW = Ashwood	GL = Gloss	LZ = LineZ	PV = Polished Velvet	TL = Timberline
BB = Barnboard	GR = Granite	MG = Medium Gloss	SD = Suede	TW = Tactile Weave
CR = Crystal	GV = Groovy	MZ = Metalz	SL = Slate	VE = Velvet
				WE = Wood Essence

When ordering, please reference the laminate NUMBER, not the name. Some colors and/or finishes may require 5-10 sheet minimums.

Dark solids or Gloss finish laminates will show wear and scratches. WE DO NOT RECOMMEND them for normal kitchen use!

UPCHARGES PER LINEAL FOOT

MANY NON-STOCK COLORS ARE AVAILABLE IN LIMITED SIZES, BALANCE OF LAMINATE MAY NEED TO BE PURCHASED.

*ALLOW ADDITIONAL LEAD TIME ON NON-STOCK COLORS. NOT ALL COLORS/FINISHES MAY BE LISTED.

WILSONART

GROUP	GROUP	GROUP	GROUP	GROUP	GROUP	GROUP	GROUP	GROUP							
1500-60	1	1889K-07	3	4856-60	0	4971K-52	3	5037-38	0	7946-38	0	8205K-16	3	17012K-57	4
1530-60	1	1890K-22	3	4857-60	0	4978K-07	3	5038-15	4	7947K-18	3	8207K-16	3	17013K-57	4
1570-60	1	1891K-55	4	4860K-07	3	4979K-07	3	5039K-15	4	7948K-07	3	8208K-16	3	17014K-57	4
1572-60	1	2932-60	0	4862K-07	3	4980K-22	3	5041-15	4	7949K-18	3	8209K-28	3	D12K-18	3
1573-60	1	4142-60	0	4886-52	3	4981-38	0	5042K-07	3	7951K-18	3	8210K-28	3	D14-60	1
1595-60	1	4143-60	0	4876-38	0	4987K-07	3	5043-15	4	7952K-18	3	8211K-28	3	D25-60	1
1799K-07	3	4168-60	0	4877-38	0	4988K-07	3	5044-60	0	7953-38	0	8212K-28	3	D30-60	1
1814K-35	4	4170-60	0	4878-38	0	4990-38	0	5045K-15	4	7954-38	0	8213K-28	3	D50-60	1
1815K-35	4	4551K-01	2	4879-38	0	4991-38	0	5046-15	4	7957K-78	3	8214K-28	3	D73-60	1
1818K-35	4	4588K-07	3	4880-38	0	4992-38	0	5057K-18	3	7959K-78	3	8215K-12	3	D90-60	1
1820K-35	4	4588-60	0	4882-38	1	4995-60	0	5058K-18	3	7960K-18	3	8216K-28	3	D91-60	1
1822K-35	4	4589K-07	3	4883-38	0	4996-38	0	5062-38	0	7964K-12	3	8217K-16	3	D92-28	3
1824K-35	4	4595K-52	3	4886-38	0	4998K-22	3	5063K-22	3	7965K-12	3	8218-38	0	D92-60	1
1826K-35	4	4621-60	0	4887-38	0	4999K-22	3	5064-60	0	7966K-12	3	8219-38	0	D96-60	1
1832K-35	4	4622-60	0	4888-38	1	5000K-22	3	5067K-15	4	7967K-12	3	8220-38	0	D307-60	1
1842K-35	4	4623-60	0	4897K-01	3	5001K-07	3	7039K-78	3	7968K-12	3	8221-38	0	D315-60	1
1849K-35	4	4630-60	0	4904-38	0	5002K-07	3	7040K-78	3	7969K-12	3	8222K-16	3	D321-60	1
1850K-35	4	4651-60	0	4905-38	0	5003-38	0	7054-60	0	7970K-18	3	8226-79	3	D327-60	1
1854K-35	4	4656-60	0	4907-38	0	5004-38	0	7110K-78	3	7971K-12	3	8225K-79	3	D354-60	0
1858K-55	4	4667-60	0	4921K-52	3	5005-38	0	7122K-07	3	7973K-12	3	8232K-05	4	D379-60	1
1863K-55	4	4669-60	0	4922K-52	3	5006K-07	3	7209K-78	3	7975K-12	3	8229-79	3	D381-60	1
1864K-55	4	4674-60	0	4923K-52	3	5008K-07	3	7806-60	0	7976K-12	3	8231-79	3	D388-60	1
1867K-55	4	4724-60	0	4924-38	0	5009-60	0	7816-60	0	7977K-12	3	8234-05	4	D403-60	1
1870K-55	4	4724K-52	3	4925K-07	3	5010K-07	3	7850-60	0	7980K-18	3	8235-05	4	D417-60	1
1871K-35	4	4725-60	0	4926K-07	3	5011K-22	3	7909-60	0	7981K-12	3	8236-05	4	D427-60	1
1872K-35	4	4725K-52	3	4929-38	0	5012-19	3	7911-60	0	7982-38	0	8238-05	4	D431-60	1
1874K-35	4	4726-60	0	4931-38	0	5013-19	3	7919K-78	3	7983-38	0	8239-38	0	D439-60	1
1874K-52	3	4726K-52	3	4932-38	0	5014-19	3	7921-38	0	7984-38	0	8241-38	0	D495-60	1
1875K-35	4	4746-60	0	4932K-52	3	5015-38	0	7922K-07	3	7985-38	0	8242-38	0	D498-18	3
1875K-52	3	4762-60	0	4939K-18	3	5016-38	0	7923K-07	3	7986-38	0	10657-60	0	D501-60	1
1876K-35	4	4783-60	0	4940K-18	3	5017-38	0	7924K-07	3	7987-38	0	10734-60	0	D502K-18	3
1876K-52	3	4795-60	0	4941-18	3	5018-38	0	7925-38	0	7990-38	0	10745-60	0	D503-60	1
1877K-35	4	4796-60	0	4942-38	0	5022K-22	3	7928-38	0	7991-38	0	10776-60	0	D504-60	1
1877K-52	3	4810-60	0	4943-38	0	5023K-19	3	7929-38	0	7992-38	0	13088-60	0	D505-60	1
1878K-35	4	4811-60	0	4944-38	0	5024K-19	3	7933K-07	3	7993-38	0	13089-60	0	17015K-67	4
1879K-35	4	4814-60	0	4945-38	0	5025K-22	3	7935K-07	3	7994-38	0	13091-60	0	17016K-67	4
1880K-35	4	4820-60	0	4946-38	0	5026K-07	3	7936K-07	3	7995-38	0	13092-60	0	17017K-67	4
1881K-35	4	4830K-18	3	4947-38	0	5027K-07	3	7937-38	0	7996-38	0	13096-60	0	17018K-67	4
1882K-35	4	4835-38	0	4948K-22	3	5028K-07	3	7938-38	0	7997-38	0	13102-60	0		
1883K-35	4	4841-60	0	4951K-22	3	5029K-22	3	7939K-18	3	7998K-18	3	17000-57	4		
1884K-35	4	4842-60	0	4952K-22	3	5031K-07	3	7941K-18	3	7999K-12	3	17001-57	4		
1885K-07	3	4843-60	0	4953K-22	3	5033-38	0	7942K-07	3	8200K-16	3	17002-57	4		
1886K-07	3	4844-60	0	4954K-22	3	5034-38	0	7943K-07	3	8201K-12	3	17003-57	4		
1887K-22	3	4845-60	0	4955K-22	3	5035-38	0	7944K-01	3	8203K-28	3	17004-57	4		
1888K-22	3	4846-60	0	4957K-22	3	5036-38	0	7945K-18	3	8204K-16	3	17005-57	4		

FINISHES

01 = Gloss	15 = Fieldstone	21 = Soft Silk	38 = Fine Velvet Textured	60 = Matte
05 = Timbergrain	16 = Casual Rustic	22 = Antique	52 = Quarry	67 = Aligned Walnut
07 = Textured Gloss	18 = Linearity	28 = Gloss Line	55 = Glaze HD	78 = FineGrain
12 = Soft Grain	19 = Leno Weave	35 = Mirage HD	57 = Aligned Oak	79 = Ridgewood
				K = AEON Finish

When ordering, please reference the laminate NUMBER, not the name. Some colors and/or finishes may require 5-10 sheet minimums.

Dark solids or Gloss finish laminates will show wear and scratches. WE DO NOT RECOMMEND them for normal kitchen use!



FORMICA

MANY NON-STOCK COLORS ARE AVAILABLE IN LIMITED SIZES, BALANCE OF LAMINATE MAY NEED TO BE PURCHASED.

*ALLOW ADDITIONAL LEAD TIME ON NON-STOCK COLORS. NOT ALL COLORS/FINISHES MAY BE LISTED.

GROUP	GROUP	GROUP	GROUP	GROUP	GROUP	GROUP	GROUP	GROUP	GROUP	GROUP	GROUP	GROUP	GROUP	GROUP					
118-58	0	912-ML	3	1198-90	3	3526-46	3	5019-34	3	6222-43	0	6998-58	0	7739-58	0	8792-90	3	9302-34	4
271-46	0	914-58	1	1485-58	1	3526-58	0	5019-58	0	6222-58	0	6999-58	0	7747-58	0	8792-PX	3	9303-43	4
271-90	3	914-90	3	1485-90	3	3546-46	4	5323-58	1	6222-RD	3	7008-43	0	7759-43	0	8793-58	1	9303-RD	4
299-58	0	918-58	1	1545-PG	3	3546-ML	4	5323-90	3	6223-34	3	7012-58	0	7812-58	0	8793-90	3	9306-34	3
346-58	0	918-90	3	1547-PG	3	3547-34	4	5342-58	1	6223-43	0	7018-58	0	7812-SP	3	8793-ML	3	9306-58	0
459-58	1	918-SP	3	2200-58	1	3547-RD	4	5342-90	3	6223-58	0	7022-58	0	7813-58	0	8795-58	1	9306-ML	3
463-58	1	920-58	1	2200-90	3	3690-34	3	5342-ML	3	6223-RD	3	7197-58	1	7813-SP	3	8795-90	3	9307-34	3
463-90	3	920-90	3	2200-MC	3	3690-58	0	5342-SP	3	6226-46	3	7197-90	3	7872-58	1	8796-58	1	9307-58	0
463-MC	3	923-58	1	2200-SP	3	3692-46	3	5349-58	1	6226-58	0	7197-ML	3	7872-90	3	8796-90	3	9308-46	3
463-PX	3	923-90	3	2297-58	1	3692-58	0	5349-90	3	6227-46	3	7213-58	0	7872-PX	3	8796-PG	3	9308-58	0
464-58	1	927-58	1	2297-90	3	3692-RD	3	5349-PX	3	6227-58	0	7264-34	3	7897-58	1	8822-58	1	9309-46	3
464-90	3	927-90	3	2297-MC	3	3700-11	4	5349-SP	3	6280-46	3	7264-58	0	7897-90	3	8822-90	3	9309-58	0
469-90	3	927-SP	3	2297-PX	3	3701-11	4	5487-26	3	6280-58	0	7267-34	3	7966-58	1	8824-58	0	9310-58	0
503-58	0	928-58	1	2770-58	1	3702-34	4	5488-26	3	6280-RD	3	7267-58	0	7966-90	3	8826-58	0	9312-58	0
507-58	0	928-90	3	2770-90	3	3703-11	4	5489-26	3	6306-58	0	7288-58	0	8235-58	1	8827-58	0	9318-BH	3
515-58	0	928-ML	3	2962-58	1	3704-11	4	5782-NG	3	6307-58	0	7402-11	4	8235-90	3	8828-58	0	9319-BH	3
692-58	0	929-58	1	2962-90	3	3705-58	0	5783-NG	3	6314-34	3	7403-11	4	8235-PX	3	8829-58	0	9320-PA	3
756-58	0	929-90	3	3202-58	1	3706-58	0	5784-NG	3	6314-58	0	7403-58	4	8238-58	1	8830-34	3	9476-43	0
758-58	0	932-58	1	3202-90	3	3706-ML	3	5785-NG	3	6319-43	4	7404-11	4	8238-90	3	8830-58	0	9476-46	3
827-46	3	932-90	3	3245-90	3	3707-58	0	5786-NG	3	6319-RD	4	7405-34	4	8238-PX	3	8831-58	0	9476-58	0
827-58	0	933-58	1	3420-46	4	3707-ML	3	5787-NG	3	6320-46	4	7406-34	3	8240-58	1	8841-WR	3	9479-NG	4
837-58	1	933-90	3	3422-11	4	3708-58	0	5788-NG	3	6330-90	3	7406-58	0	8240-90	3	8842-WR	3	9483-11	4
837-90	3	934-58	1	3422-RD	4	3709-58	0	5789-43	0	6362-NG	3	7407-34	3	8241-58	1	8843-WR	3	9483-34	4
839-58	1	934-90	3	3450-43	0	3710-43	0	5790-43	0	6372-NG	3	7407-58	0	8241-90	3	8844-WR	3	9484-58	0
839-90	3	949-42	3	3450-58	0	3711-34	3	5791-PG	3	6402-43	0	7408-43	0	8243-58	1	8845-58	0	9497-34	3
845-58	1	949-58	0	3450-RD	3	3712-58	0	5792-PG	3	6696-46	3	7408-58	0	8243-90	3	8846-58	0	9497-58	0
845-90	3	949-90	3	3456-46	3	3712-NG	3	5793-NG	3	6696-58	0	7409-43	0	8244-58	1	8848-58	0	9510-34	3
851-58	1	949-MC	3	3456-58	0	3720-90	3	5794-NG	3	6697-46	3	7409-58	0	8244-90	3	8849-58	0	9511-34	3
851-90	3	949-ML	3	3460-11	4	3720-ML	3	5795-NG	3	6697-58	0	7410-11	4	8552-NG	3	8858-58	1	9512-34	3
858-58	1	949-NG	3	3460-46	4	4923-NG	3	5796-NG	3	6698-46	3	7411-11	4	8576-PG	3	8858-90	3	9525-58	0
858-90	3	949-PX	3	3466-11	4	4924-NG	3	5875-58	0	6698-58	0	7412-58	0	8589-PG	3	8858-PX	3	9527-34	3
899-58	1	949-SP	3	3466-RD	4	4925-NG	3	5880-58	0	6901-58	1	7412-PG	3	8676-26	3	8905-58	0	9527-58	0
899-90	3	961-58	1	3476-46	4	4971-58	0	5882-58	0	6901-90	3	7413-58	0	8677-26	3	8906-58	0	9529-58	0
902-58	1	961-90	3	3485-58	0	4971-PA	3	5883-58	0	6901-MC	3	7413-PG	3	8678-58	0	8907-NG	3	9534-34	4
902-90	3	961-MC	3	3496-46	3	4972-58	0	5884-58	0	6903-58	1	7481-58	0	8679-58	0	8908-NG	3	9534-ML	4
902-ML	3	969-58	1	3496-58	0	4972-PA	3	5886-43	0	6903-90	3	7494-58	0	8680-58	0	8909-NG	3	9536-34	4
909-42	3	969-90	3	3505-58	0	4973-58	0	5887-26	3	6903-MC	3	7500-58	0	8681-58	0	8910-NG	3	9536-ML	4
909-58	1	1097-58	1	3505-SP	3	4973-PA	3	5904-43	0	6920-58	0	7708-58	0	8682-58	0	8916-NG	3	9537-34	4
909-90	3	1097-90	3	3517-46	3	4974-58	0	6206-43	0	6925-26	3	7732-46	3	8683-58	0	8918-58	0	9684-58	1
909-MC	3	1097-MC	3	3517-58	0	4974-PA	3	6208-43	0	6932-26	3	7732-58	0	8684-58	0	8919-58	0	9685-58	1
909-NG	3	1193-58	1	3518-46	3	5014-11	4	6209-43	0	6942-58	0	7734-46	3	8685-NG	3	8958-58	0		
909-PX	3	1193-90	3	3518-58	0	5015-11	4	6212-58	0	6994-26	3	7734-58	0	86992-58	0	9012-26	3		
909-SP	3	1196-58	1	3522-46	3	5016-11	4	6220-58	0	6995-26	3	7735-46	3	8751-58	1	9284-43	4		
912-58	1	1196-90	3	3522-58	0	5017-11	4	6220-RD	3	6996-26	3	7735-58	0	8751-90	3	9284-RD	4		
912-90	3	1198-58	1	3526-34	3	5018-11	4	6222-34	3	6997-58	0	7738-58	0	8792-58	1	9285-58	0		

FINISHES

- | | | | | |
|------------------|---------------|--------------------|-----------------|----------------|
| 11 = Satin Touch | 43 = Artisan | BH = Brush | NT = Naturelle | RD = Radiance |
| 26 = Oiled Wood | 46 = Etchings | MC = MicroDot | PG = Pure Grain | SP = Sculpted |
| 34 = Scovato | 58 = Matte | ML = Monolith | PX = Plex | WR = Woodbrush |
| 42 = Crystal | 90 = Gloss | NG = Natural Grain | | |

When ordering, please reference the laminate NUMBER, not the name. Some colors and/or finishes may require 5-10 sheet minimums.

Dark solids or Gloss finish laminates will show wear and scratches. WE DO NOT RECOMMEND them for normal kitchen use!

UPCHARGES PER LINEAL FOOT

NEVAMAR

MANY NON-STOCK COLORS ARE AVAILABLE IN LIMITED SIZES, BALANCE OF LAMINATE MAY NEED TO BE PURCHASED.

*ALLOW ADDITIONAL LEAD TIME ON NON-STOCK COLORS. NOT ALL COLORS/FINISHES MAY BE LISTED.

GROUP	GROUP	GROUP	GROUP	GROUP	GROUP	GROUP	GROUP								
AB2400T	1	CK2002T	1	MR3008T	1	S2037T	1	SG052GL	2	VA2002T	1	WK0024T	1	WX0075AB	2
AB4440T	1	EM6001T	1	MR5007T	1	S2050T	1	SG052T	1	VA5001T	1	WK0025T	1	WX1150PV	2
AE0500SD	1	ES2001T	1	MR6001T	1	S2063T	1	S6053GV	2	VA5002T	1	WK0027FL	2	WX4600VE	2
AG1000T	1	ES2003T	1	MR6002T	1	S2069T	1	S6053SM	2	VA6001T	1	WK0027T	1	WX8500VE	2
AG1900T	1	ES6002T	1	MR6004T	1	S2084T	1	S6053T	1	VA7002T	1	WM0005T	1	WY2000T	1
AG6300SD	1	ES7001T	1	MR6005T	1	S2086T	1	S6054T	1	VE6001T	1	WM0046T	1	WZ0001T	1
AG7600NS	2	FN1002T	1	MR6006T	1	S2093T	1	S7004T	1	VS2001T	1	WM0047AB	2	WZ0002T	1
AG7900EV	3	FN6001T	1	MR6007T	1	S2110T	1	S7005T	1	VS2003T	1	WM0047T	1	WZ0003T	1
AG8000LZ	2	FS2001T	1	MR6008T	1	S2115GV	2	S7024BB	2	VS5002T	1	WM2640T	1	WZ0005MG	2
AG8000SD	1	FS6001T	1	MR7001T	1	S2115T	1	S7024GV	2	VS6001T	1	WM5528SD	1	WZ0017T	1
AG8100SD	1	FZ2001T	1	MT2500EV	3	S3016T	1	S7025T	1	VS6002T	1	WM5577SD	1	WZ0018T	1
AG8720SD	1	GR2004T	1	MT4050EV	3	S3022T	1	S7027T	1	VU6001T	1	WM8110T	1	WZ0028PV	2
AL2002T	1	GR4001T	0	MW5350VE	2	S3023T	1	S7032T	1	W8294T	1	WM8164T	1	WZ0045T	1
AL2004T	1	HLB001T	1	MW5450VE	2	S3048T	1	S7036T	1	W8325T	1	WM8258T	1	WZ0049T	1
AL5001T	1	HLT001T	1	MW5500NS	2	S3055T	1	S7038T	1	W8343PV	2	WM8322T	1	WZ0049TL	2
AL5002T	1	HLT004T	1	MW5700EV	3	S3068T	1	S7040T	1	W8348VE	2	WM8340T	1	WZ0052T	1
ALB001T	1	KH2001T	1	MW5800EV	3	S3069T	1	S8001T	1	W8351T	1	WM8342T	1	WZ0053T	1
ALN002T	1	LN6001T	1	MW5850VE	2	S3070T	1	S8002T	1	W8352VE	2	WM8349T	1	WZ0054T	1
ALR003T	1	LN6002T	0	MW5900EV	3	S4022T	1	S8003T	1	W8369T	1	WM8350T	1	WZ0055T	1
ALT005T	1	LU3001T	1	MW6000EV	3	S4025T	1	SB0300FL	2	W8371T	1	W00040T	1	WZ0056T	1
AM6001T	1	LU6001T	1	MXT002T	1	S5052T	1	SB0300T	1	WA0001SD	1	W01400WE	2	WZ0057T	1
A03200T	1	ME0600SD	0	MXT003T	1	S5057T	1	SG0004T	1	WA0002SD	1	W07100WE	2	WZ0062T	1
AR2830T	1	ME1000EV	3	PDG002T	1	S5059T	1	SH2002T	1	WA3000VE	2	WP3000AB	2	WZ0063T	1
AT1810EV	3	MG0930EV	3	PH7001T	1	S6001T	1	SL2001T	1	WC2001T	1	WS9450MG	2	WZ0080TL	2
AT5100T	3	MG1150EV	3	PO7001T	0	S6003T	1	SL6002T	1	WC5581MG	2	WT0003PV	2	WZ1001T	1
AT7500SD	1	MG1200EV	3	PR2002T	1	S6012T	1	SL6003EV	3	WD0001T	1	WT0004T	1	WZ2001T	1
AT7500TL	2	MG1300EV	3	RK2001T	0	S6014T	1	SL6003T	0	WE2700T	1	WT0005T	1	WZ2004T	1
AT7700T	1	MG1600EV	3	RK2002T	1	S6020T	1	SP4170T	1	WF0001T	1	WU0005T	1	WZ2007PV	2
AT9960EV	3	MG1800EV	3	RK2001NS	2	S6023GV	2	SR5100T	1	WF0002SD	1	WU0010WE	2	WZ2009T	1
AV2100T	1	MH4001T	1	RK2001T	1	S6023T	1	SR5240FL	2	WF0011AB	2	WU0030WE	2	WZ3001T	1
AV4000T	1	MH6001T	1	RK6003T	0	S6024T	1	SR5240T	1	WF0011T	1	WU0060T	1	WZ5001T	1
AW1410NS	2	MH8001T	1	RK7002T	0	S6027T	1	SV7300T	1	WH0050PV	2	WW0013MG	2	WZ6001T	1
AW1800T	1	MR1200EV	3	S1015T	1	S6031T	1	SV7410FL	2	WH1000WE	2	WW0900VE	2	WZ6004T	1
AW1900VE	2	MR2002T	1	S1027LZ	2	S6033T	1	SY9250T	1	WK0017BB	2	WW3100T	1	YSN001T	1
AY1500T	1	MR2003T	1	S1027T	1	S6037T	1	TM2001T	1	WK0017T	1	WW4400VE	2	YSN002T	1
AV2100T	1	MR2006T	1	S1049T	1	S6047T	1	TM2002T	1	WK0022T	1	WW7800T	1		
AY1300SD	1	MR3003T	1	S2019T	1	S6052T	1	VA2001T	1	WK0023PV	2	WW9000WE	2		
											WW9600T	1			

FINISHES

AB = Aged Bark	FL = Fineline	LZ = LineZ	SD = Suede	TW = Tactile Weave
AS = Aegis Secure	GL = Gloss	MG = Medium Gloss	SL = Slate	VE = Velvet
AW = Ashwood	GR = Granite	MZ = Metalz	SM = Super Matte	WE = Wood Essence
BB = Barnboard	GV = Groovy	NS = Natural Stone	SX = StoneX	
CR = Crystal	HX = Hex	NW = Natural Wood	T = ARP (Armored Protection)	
EV = Evolution	LR = Soft Leather	PV = Polished Velvet	TL = Timberline	

When ordering, please reference the laminate NUMBER, not the name. Some colors and/or finishes may require 5-10 sheet minimums.

Dark solids or Gloss finish laminates will show wear and scratches. WE DO NOT RECOMMEND them for normal kitchen use!



MANY NON-STOCK COLORS ARE AVAILABLE IN LIMITED SIZES, BALANCE OF LAMINATE MAY NEED TO BE PURCHASED.

*ALLOW ADDITIONAL LEAD TIME ON NON-STOCK COLORS. NOT ALL COLORS/FINISHES MAY BE LISTED.

ARBORITE

GROUP	GROUP	GROUP	GROUP	GROUP	GROUP	GROUP
1403GL 2	P323MX 4	P389CA 1	P500CA 1	S444CA 1	W405VL 2	W467EV 3
1439FP 2	P325MX 4	P390CA 1	P623MX 4	S445CA 1	W411VL 2	W468EV 3
1531VL 2	P326MX 4	P391CA 1	P885CA 1	S463CA 1	W412FP 2	W469EV 3
1538VL 2	P327CA 1	P392CA 0	P886CA 1	S466CA 1	W413VL 2	W472VL 2
1539EV 3	P331CA 1	P393CA 0	P948CA 1	S469CA 1	W415FP 2	W473VL 2
P124CA 1	P335CA 1	P394CA 0	P959CA 1	S477CA 1	W416VL 2	W476EV 3
P127CA 0	P340VT 3	P394VL 2	P971CA 1	S480CA 1	W418FP 2	W477EV 3
P203CA 1	P343RM 2	P395CA 0	P999CA 1	S486CA 1	W424FP 2	W478EV 3
P223CA 1	P344RM 2	P395VL 2	P1000VL 3	S497CA 1	W425FP 2	W479EV 3
P238CA 1	P345CA 0	P396VL 2	P1002VT 3	S498CA 1	W427VL 2	W480CW 3
P257CA 1	P345RM 2	P397VL 2	P1004IM 3	S508CA 1	W428VL 2	W481CW 3
P258CA 1	P346CA 0	P398CA 0	P1005VT 3	S513CA 1	W429VL 2	W482CW 3
P259CA 1	P346RM 2	P398VL 2	P1006VT 3	S517CA 1	W430VL 2	W483CW 3
P271CA 1	P348FP 2	P399CA 1	P1007IM 3	S542CA 1	W431VL 2	W484CW 3
P276CA 1	P354CA 1	P400CA 1	P1008VL 3	S548CA 1	W432RM 2	W485VL 2
P277LM 2	P356RM 2	P401CA 1	P1009VL 3	S550CA 1	W433RM 2	W486VL 2
P282FP 2	P357RM 2	P402CA 1	P1010IM 3	S568CA 1	W436FP 2	W487VL 2
P283FP 2	P362SR 4	P403CA 1	P1011IM 3	S573CA 1	W437FP 2	W488VL 2
P284FP 2	P363SR 4	P404CA 1	P1013UL 3	S573SR 4	W446FP 2	W489CW 3
P285FP 2	P364SR 4	P405CA 1	P1014UL 3	S575CA 1	W447FP 2	W490CW 3
P297SR 4	P365CA 1	P406CA 1	P1015UL 3	S575SR 4	W448FP 2	W491CW 3
P299SR 4	P366CA 1	P407CA 0	P1016UL 3	S576CA 1	W449EV 3	
P300SR 4	P367CA 1	P407VL 2	P1017VL 3	S577CA 1	W450EV 3	
P301SR 4	P368CA 1	P408RM 2	P1018VL 3	S578CA 1	W451EV 3	
P304BC 2	P376CA 1	P409RM 2	P1019BT 3	S579CA 1	W452RM 2	
P305BC 2	P377CA 1	P410RM 2	P1020BT 3	S580CA 1	W453VL 2	
P310SR 4	P378CA 1	P411RM 2	P1021BT 3	S581CA 1	W454EV 3	
P311CA 1	P379CA 1	P412RM 2	P1022VL 3	S582cA 1	W455EV 3	
P312FP 2	P380CA 1	P413RM 2	P1023BT 3	S583CA 1	W456EV 3	
P313FP 2	P381CA 1	P414CA 1	P1024BT 3	S584CA 1	W458SR 4	
P316CA 1	P382CA 1	P415CA 1	S405CA 1	W134VL 2	W459VL 2	
P317CA 1	P383CA 1	P416CA 1	S406CA 1	W138VL 2	W460VL 2	
P318CA 1	P384CA 1	P417CA 1	S407CA 1	W230VL 2	W461EV 3	
P319CA 1	P385CA 1	P418CA 1	S419CA 1	W305VL 2	W462EV 3	
P319IM 3	P386CA 1	P419CA 1	S431CA 1	W373EV 3	W464EV 3	
P320IM 3	P387CA 1	P420CA 1	S434CA 1	W403EV 3	W465EV 3	
P321IM 3	P388CA 1	P421CA 0	S436CA 1	W404VL 2	W466EV 3	

FINISHES

AW = Artisan Walnut	CA = Cashmere	FP = French Polish	LM = Luminous	SR = Structured
BC = Breccia	CW = Casual Wood	GL = Gloss	LQ = Laqwood	UL = Ultra Smooth
BT = Basalt	DI = Diamond	IM = Impression	MX = Metalux	VL = Velvatex
	EV = Evergrain	LE = Legno	RM = Refined Matte	VT = Vista

When ordering, please reference the laminate NUMBER, not the name. Some colors and/or finishes may require 5-10 sheet minimums.

Dark solids or Gloss finish laminates will show wear and scratches. WE DO NOT RECOMMEND them for normal kitchen use!

AVAILABLE EDGE PROFILES - ESSENTIALS

THE ESSENTIAL PROGRAM FROM COUNTER-FORM

Available exclusively on Slab/Blank orders.
ECO edges do not include backer on the front build down and features a particle board scribe.
Limited to the edge profiles shown below. Minimum orders do apply.

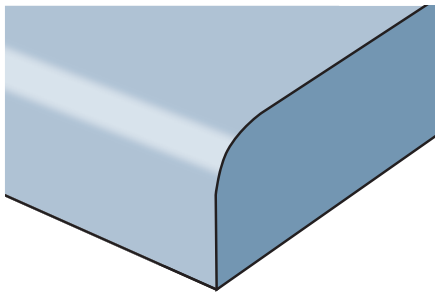

ECONO EDGE

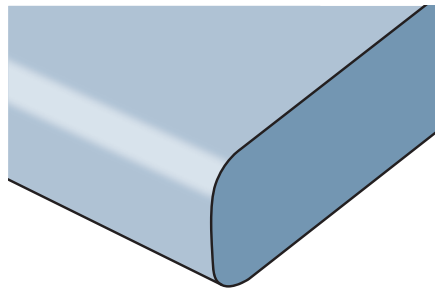

ECO "D" EDGE

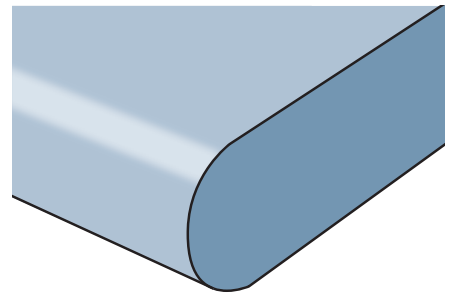

ECO 180° EDGE

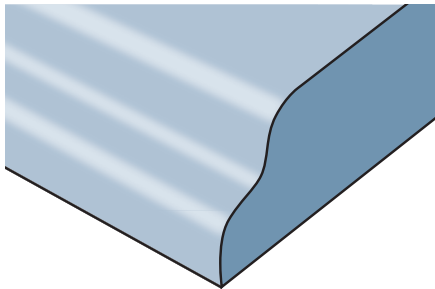

ECO ROMAN EDGE

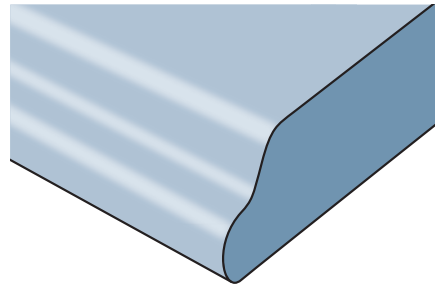

ECO PREMIER EDGE

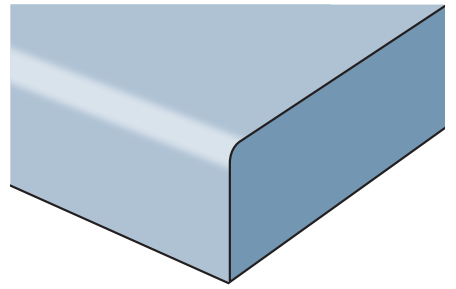

ECO REGENT EDGE

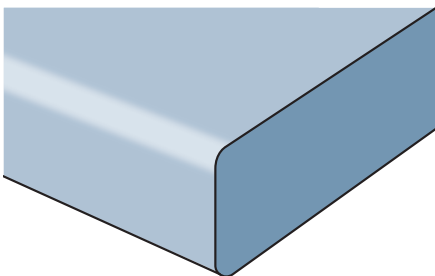

ECO MONARCH EDGE

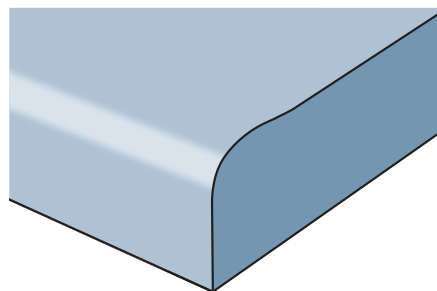

ECO NO DRIP EDGE



NO BACKER ON FRONT BUILD DOWN, PARTICLE BOARD SCRIBE STICK

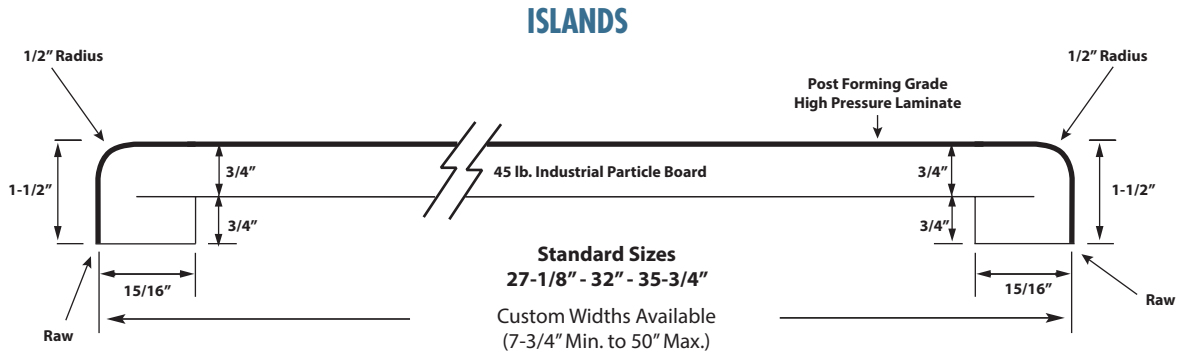
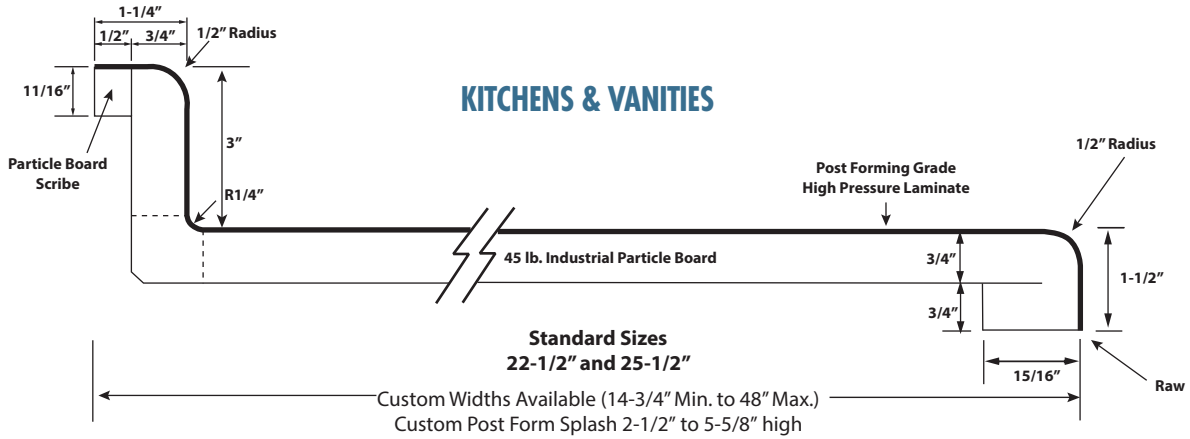

Backer is required for tops that exceed 36" in width when temperature and humidity levels are elevated.

Orders requested without backer will void warranty coverage.

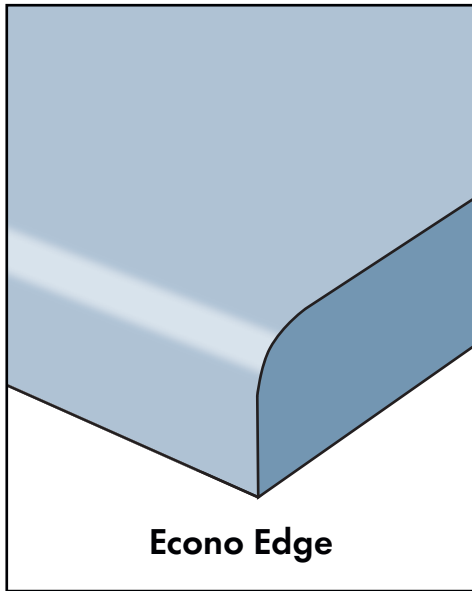

Econo Edge

SINGLE EDGE COUNTERTOPS

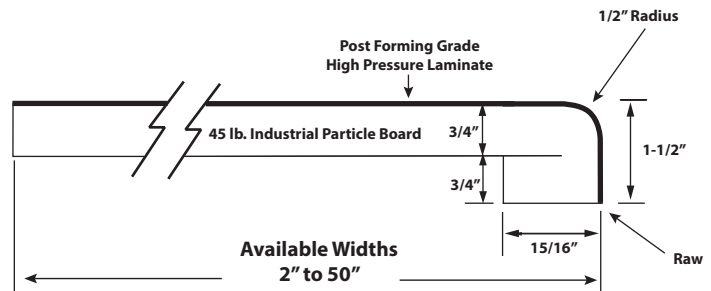

NARROW ISLANDS

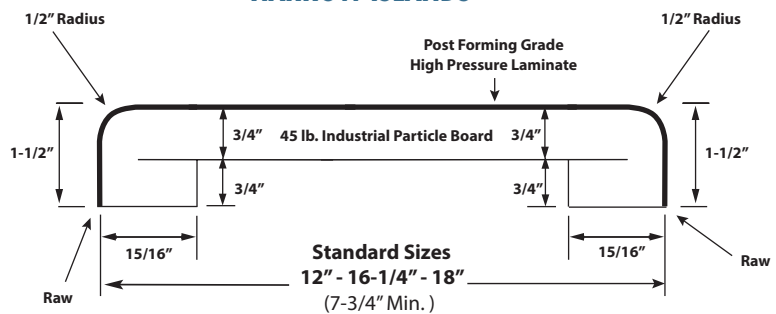

Prices Are For 8, 10, & 12' Lengths | Order Minimums Do Apply

KITCHEN TOPS	(per linear foot)
25-1/2" Deep w/ 3" B.S.....	\$17.40
25-1/4" Deep w/ 3-3/4" B.S.....	\$17.40
25" Deep w/ 4" B.S.....	\$17.40

VANITY TOPS	
22-1/2" Deep w/ 3" B.S.....	\$17.40

SINGLE EDGE TOPS	
2" to 26" Deep..... color upcharge use Kit. / Van. group.....	\$17.40
26-1/8" to 34-3/4" color upcharge use Island group (27-1/4" - 45").....	\$26.68
34-7/8" to 44" color upcharge use Island group (27-1/4" - 45").....	\$38.32

ISLAND TOPS	
12", 16-1/4" AND 18" Islands.....	\$17.40
27-1/8"	\$17.40
32" and 35-3/4"	\$26.68
45" *	\$38.32

* Backer is required for tops that exceed 36" in width when temperature and humidity levels are elevated. Orders requested without backer will void warranty coverage.

ADDITIONAL CHARGES	(priced per lin. ft.)
For 4',5',6' Lengths (Combinations must equal full length).....Add.....	\$0.90
Island Tops With Scribe.....ADD.....	\$5.50

UPCHARGES	KIT. / VAN.	ISLANDS	ISLANDS
	(up to 27-1/8" Islands)	(27-1/4" to 45")	(over 45")
Group 1..... ADD.....	\$1.60	\$2.88	\$3.20
Group 2..... ADD.....	\$3.40	\$6.12	\$6.80
Group 3..... ADD.....	\$4.42	\$7.96	\$8.84
Group 4..... ADD.....	\$10.30	\$18.54	\$20.60

TOPS W/ BACKER	
Up to 30" Deep.....ADD.....	\$6.24
30-1/8" - 45".....ADD.....	\$8.35
For Tops over 45" deep.....ADD.....	\$10.96
Non-stock rush orders are subject to a minimum charge.....	\$114.00



PARTICLE BOARD SCRIBE STICK

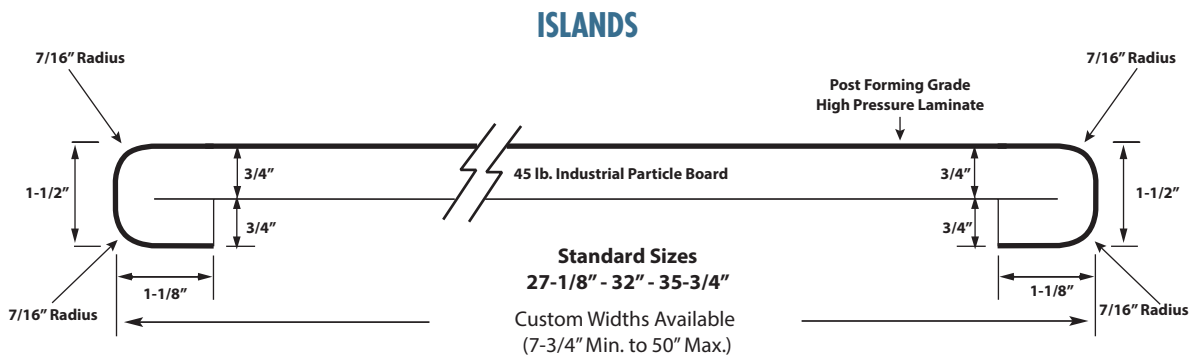
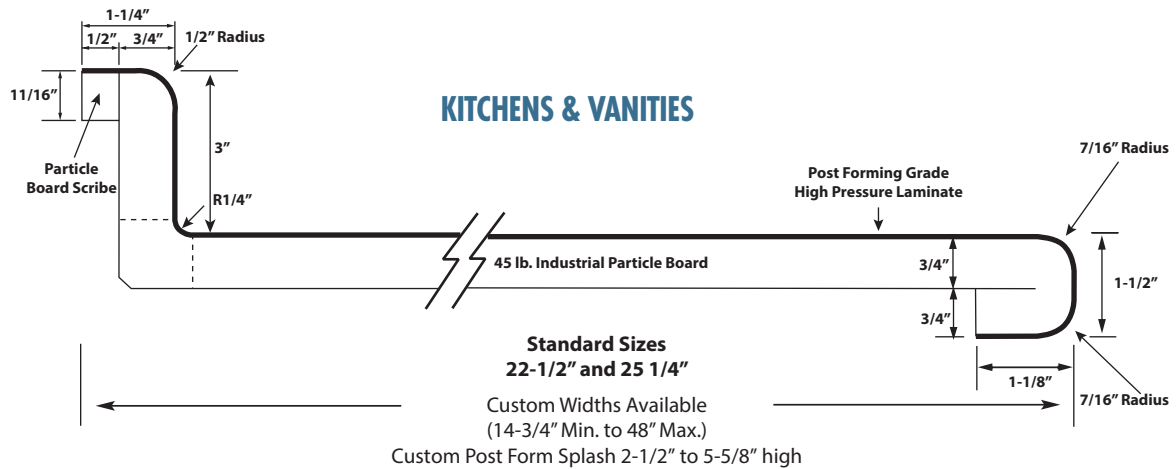

Backer is required for tops that exceed 36" in width when temperature and humidity levels are elevated.

Orders requested without backer will void warranty coverage.

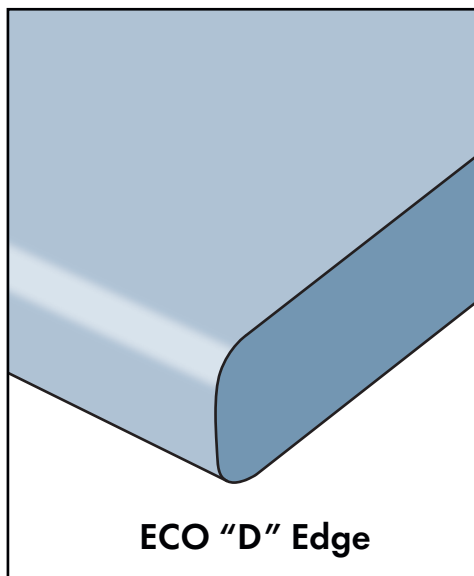

ECO "D" Edge

SINGLE EDGE COUNTERTOPS

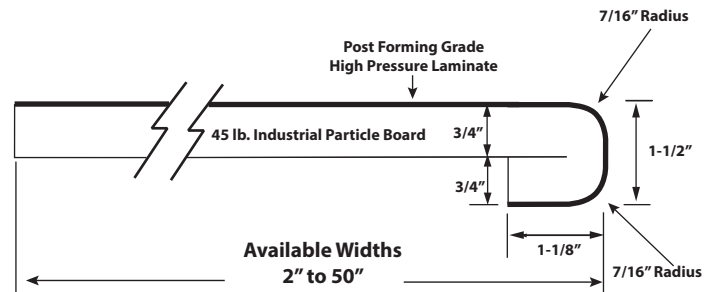

NARROW ISLANDS

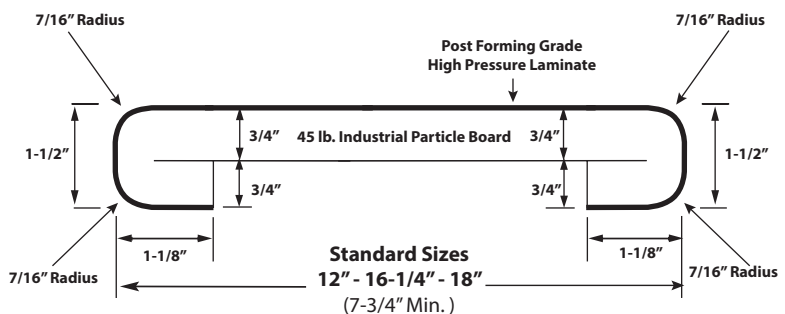

PARTICLE BOARD SCRIBE STICK

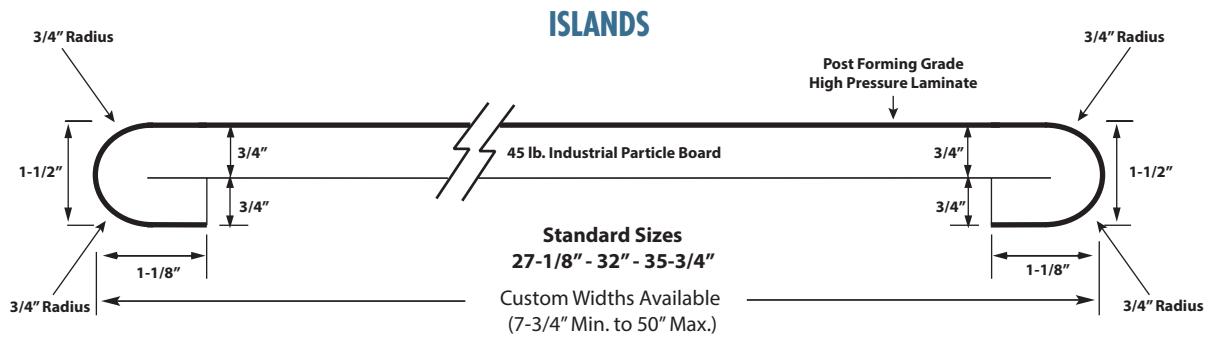
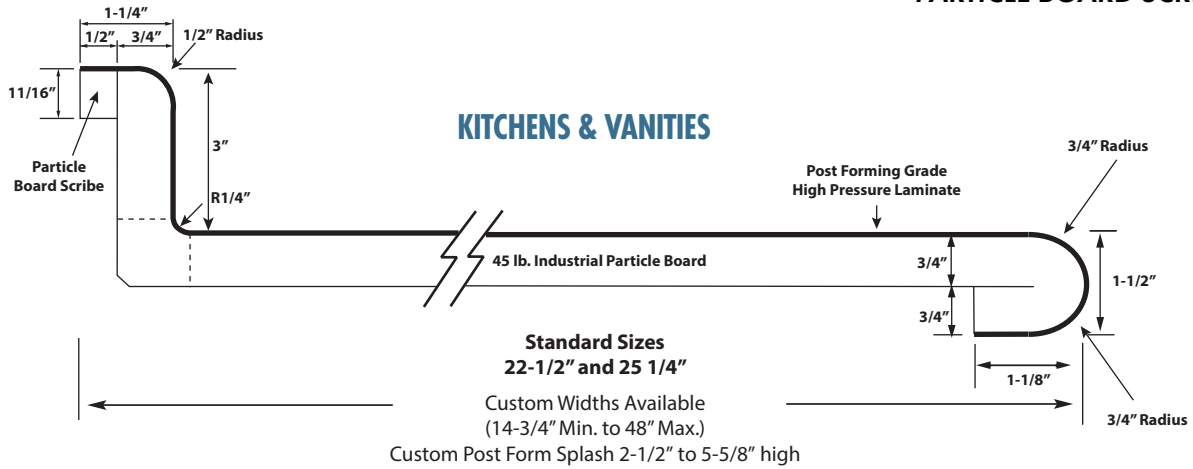

Backer is required for tops that exceed 36" in width when temperature and humidity levels are elevated.

Orders requested without backer will void warranty coverage.

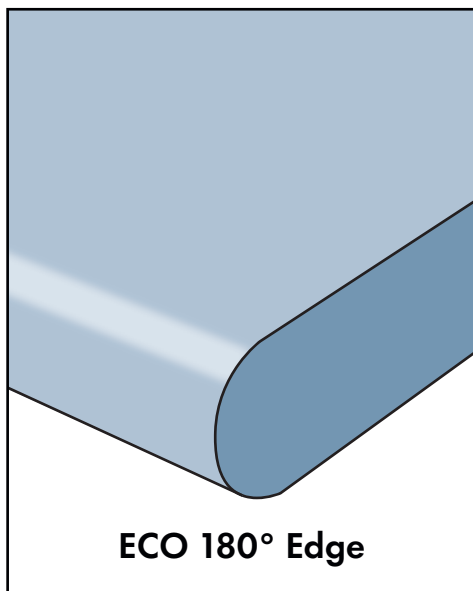

SINGLE EDGE COUNTERTOPS

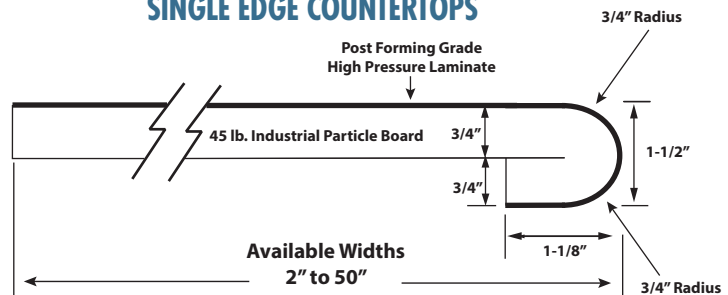

NARROW ISLANDS

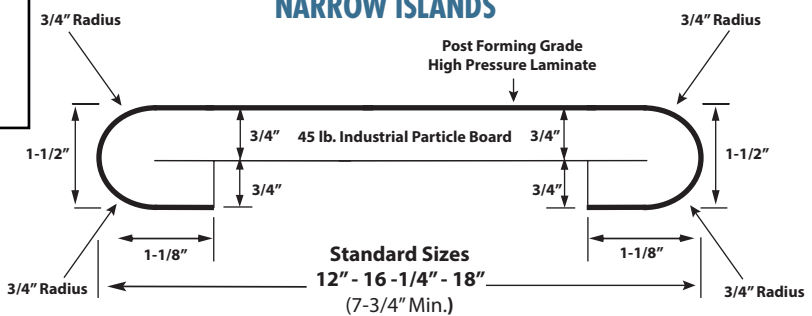



Prices Are For 8, 10, & 12' Lengths | Order Minimums Do Apply

(priced per lin. ft.)

KITCHEN TOPS

25-1/4" Deep w/ 3" Splash	\$22.20
25-1/2" Deep w/ 3" Splash (8', 10', 12' Only)	\$28.50
25-1/2" Deep w/ 4" Splash (8', 10', 12' Only)	\$28.84

VANITY TOPS

22-1/2" Deep w/ 3" Splash	\$22.20
---------------------------------	---------

SINGLE EDGE TOPS

2" to 26" Deep color upcharge use Kit. / Van. group	\$22.20
26-1/8" to 34-3/4" color upcharge use Island group (27-1/4" - 45")	\$31.48
34-7/8" to 42" color upcharge use Island group (27-1/4" - 45")	\$43.12
42-1/8" to 49" color upcharge use Island group (over 45")	\$50.72

ISLAND TOPS

12", 16-1/4" AND 18"	\$22.20
27-1/8"	\$28.26
32", 35-3/4"	\$31.48

SPECIAL DEPTH ISLANDS

7-3/4" to 27" (8', 10', 12' Only).... color upcharge use Kit. / Van. group	\$30.32
27-1/4" to 35-5/8" color upcharge use Island group (27-1/4" - 45")	\$40.02
35-7/8" to 43"* color upcharge use Island group (27-1/4" - 45")	\$43.12
43-1/8" to 50"* color upcharge use Island group (over 45")	\$50.72

* Backer is required for tops that exceed 36" in width when temperature and humidity levels are elevated. Orders requested without backer will void warranty coverage.

SPECIAL DEPTH &/OR SPLASH HEIGHT (5-5/8" HIGH MAX.)

~Overall top depth plus splash height~ (8', 10' or 12' ONLY)

Equal to or less than 28-1/4"	color upcharge use Kit. / Van. group	\$30.44
28 -3/8" up to 37"	color upcharge use Island group (27-1/4" - 45")	\$40.14
Greater than 37-1/8" up to 51"	color upcharge use Island group (over 45")	\$45.64

ADDITIONAL CHARGES

(priced per lin. ft.)

Island Tops With Scribe.....	ADD	\$5.50
------------------------------	-----------	--------

UPCHARGES

		KIT. / VAN. (up to 27-1/8" Islands)	ISLANDS (27-1/4" to 45")	ISLANDS (over 45")
Group 1	ADD	\$1.60	\$2.88	\$3.20
Group 2	ADD	\$3.40	\$6.12	\$6.80
Group 3	ADD	\$4.42	\$7.96	\$8.84
Group 4	ADD	\$10.30	\$18.54	\$20.60

TOPS W/ BACKER

Up to 30" Deep	ADD	\$6.24
30-1/8" - 45"	ADD	\$8.35
For Tops over 45" deep	ADD	\$10.96

Non-stock rush orders are subject to a minimum charge\$114.00



Not available with certain colors and finishes.

NO BACKER ON FRONT BUILD DOWN, PARTICLE BOARD SCRIBE STICK

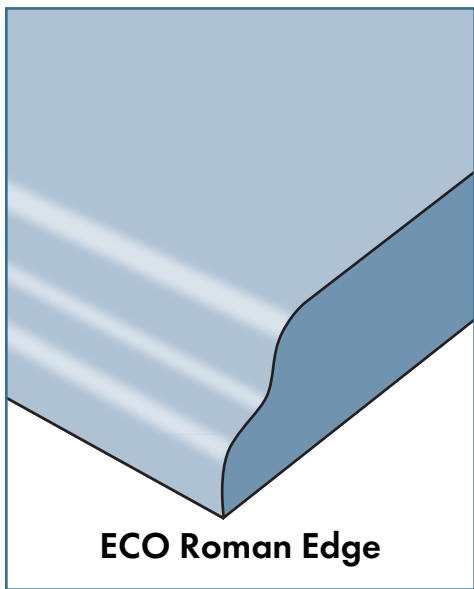
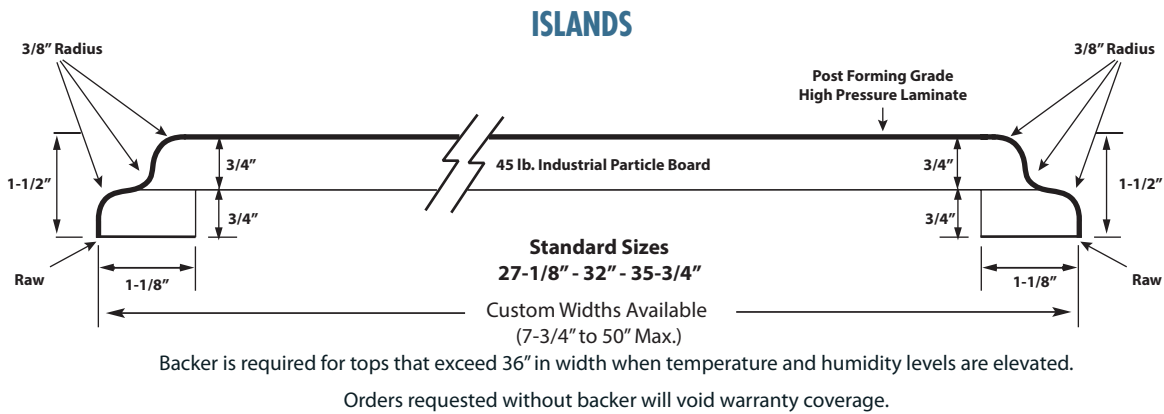
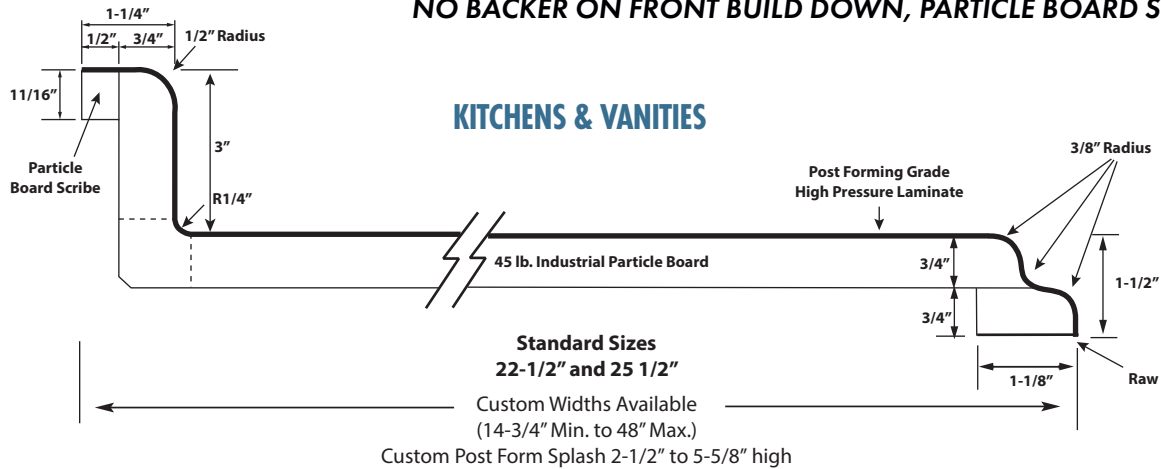

SINGLE EDGE COUNTERTOPS

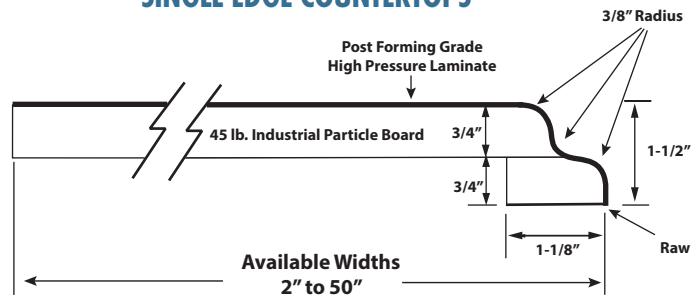

NARROW ISLANDS

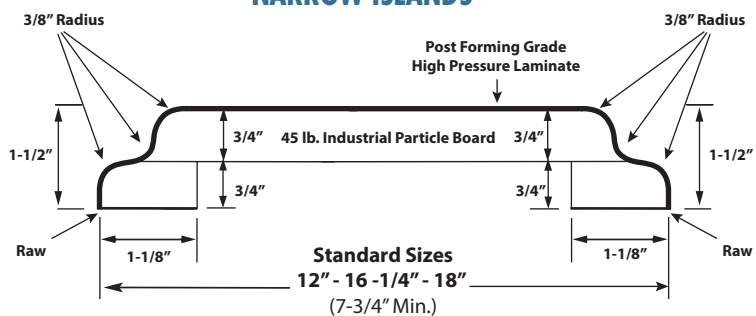

Not available with certain colors and finishes.

PARTICLE BOARD SCRIBE STICK

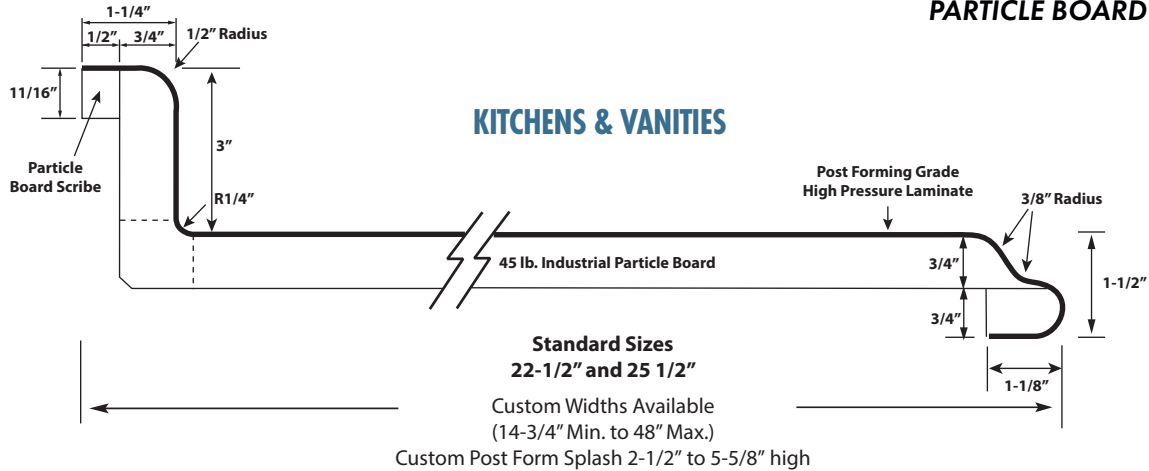

ISLANDS

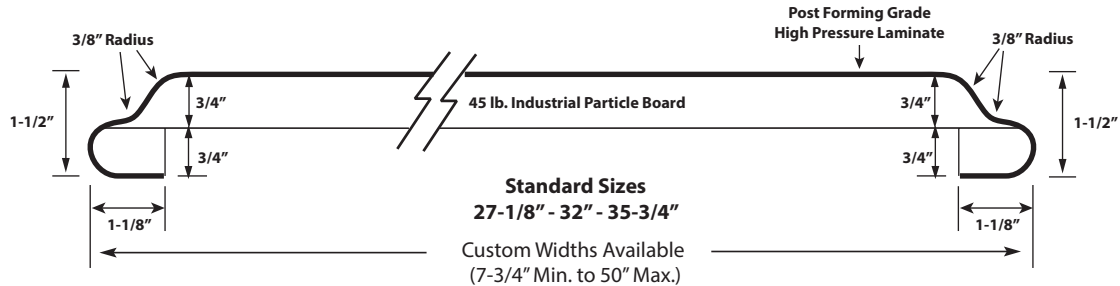

Backer is required for tops that exceed 36" in width when temperature and humidity levels are elevated.

Orders requested without backer will void warranty coverage.

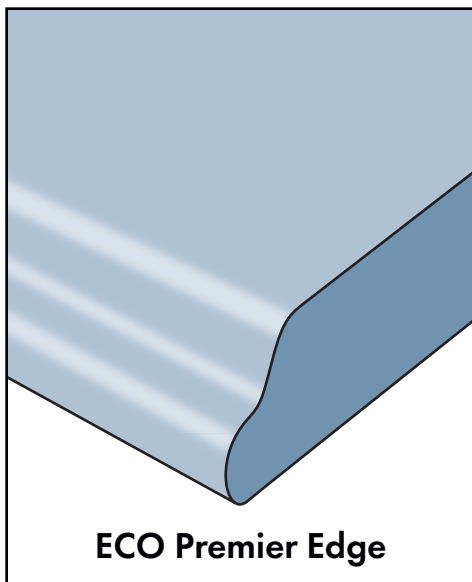

SINGLE EDGE COUNTERTOPS

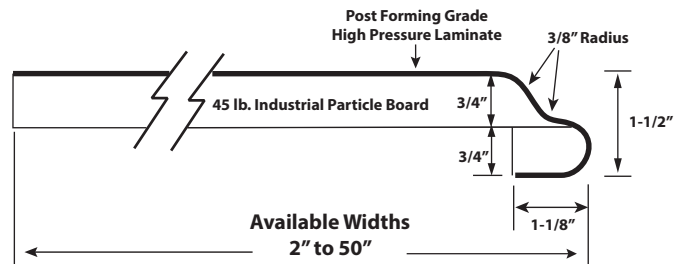

NARROW ISLANDS

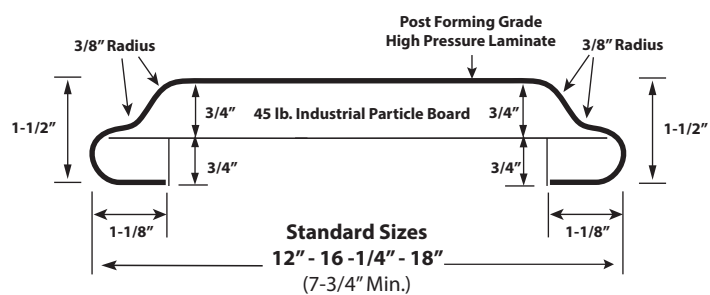



Not available with certain colors and finishes.

NO BACKER ON FRONT BUILD DOWN, PARTICLE BOARD SCRIBE STICK

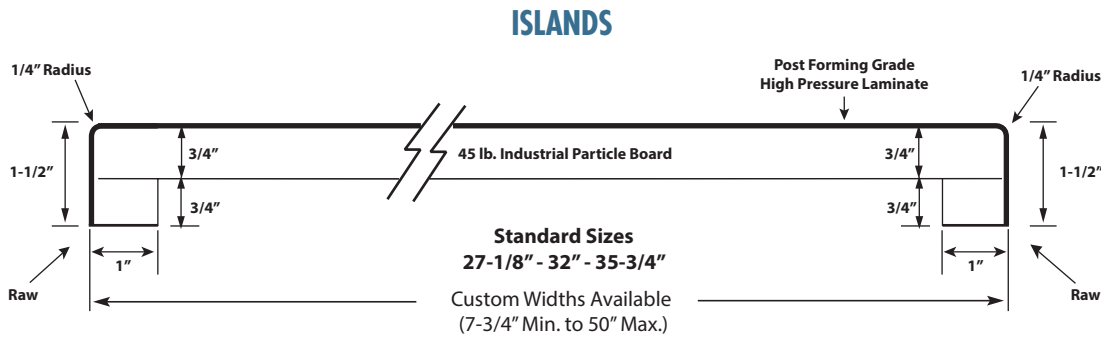
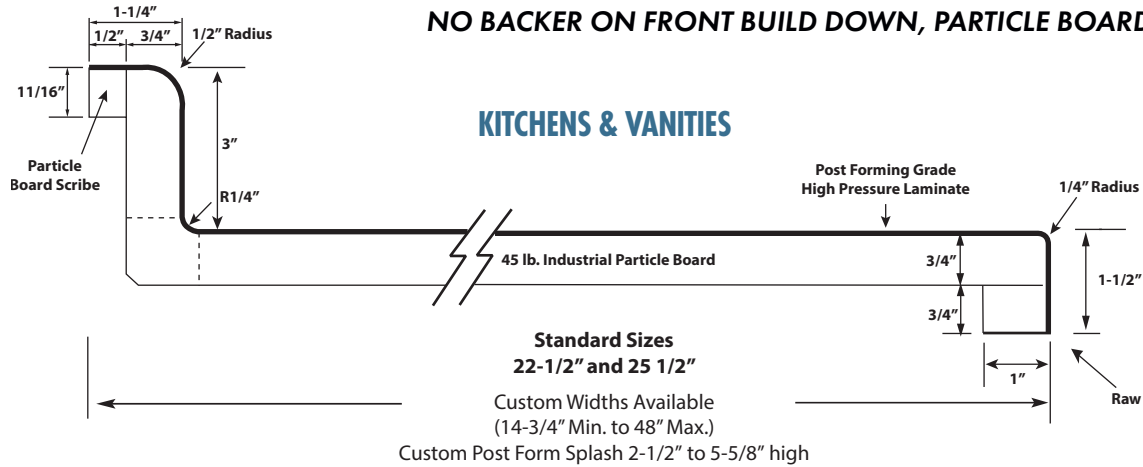

Backer is required for tops that exceed 36" in width when temperature and humidity levels are elevated.

Orders requested without backer will void warranty coverage.

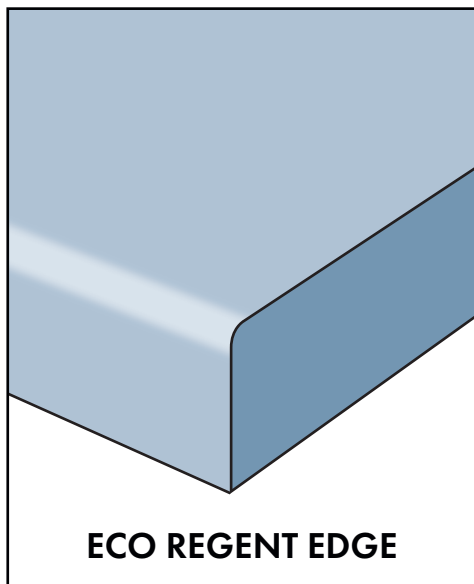

SINGLE EDGE COUNTERTOPS

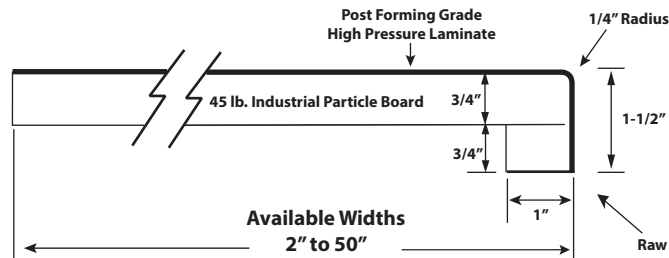

NARROW ISLANDS

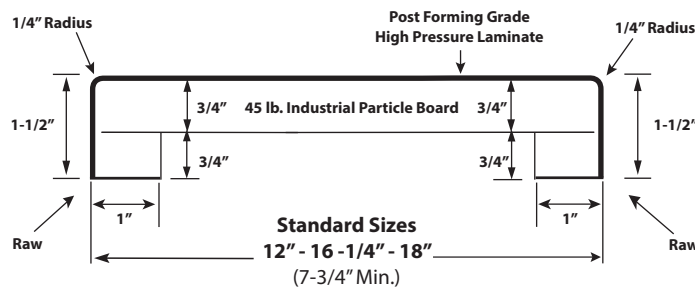

Not available with certain colors and finishes.

PARTICLE BOARD SCRIBE STICK

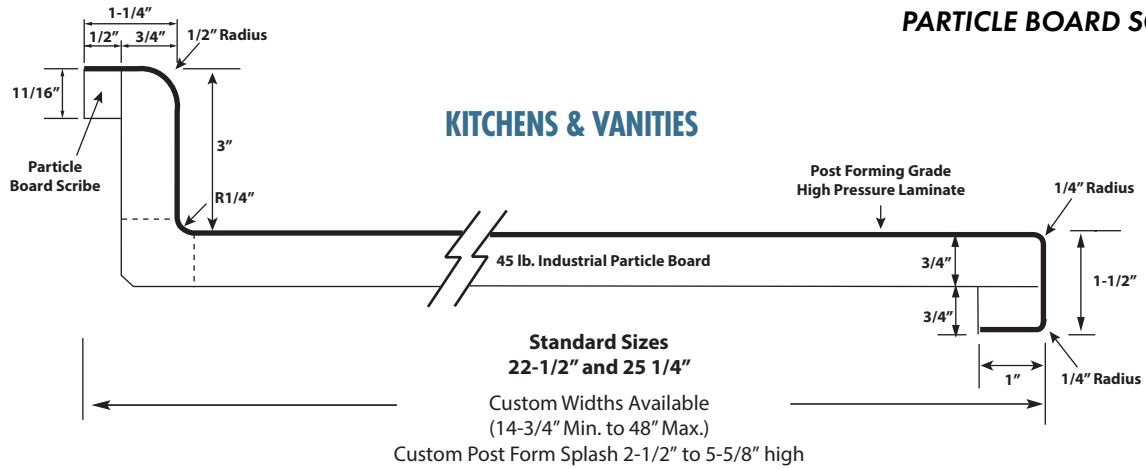

ISLANDS

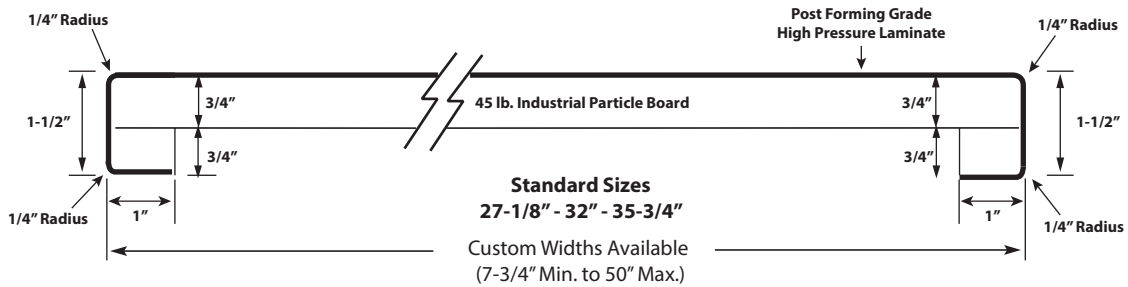

Backer is required for tops that exceed 36" in width when temperature and humidity levels are elevated.

Orders requested without backer will void warranty coverage.

SINGLE EDGE COUNTERTOPS

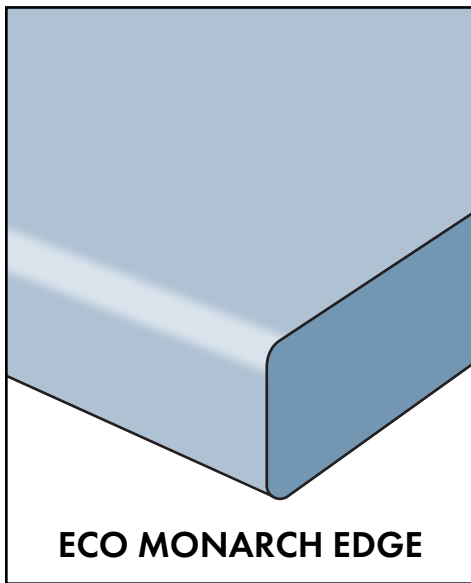
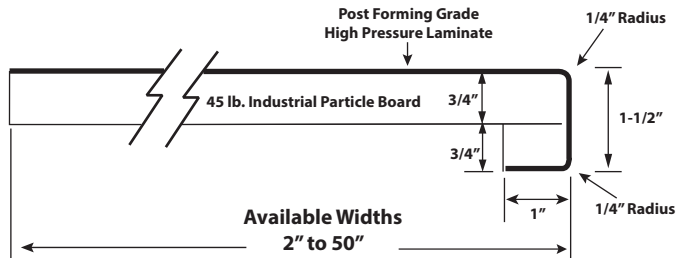

NARROW ISLANDS

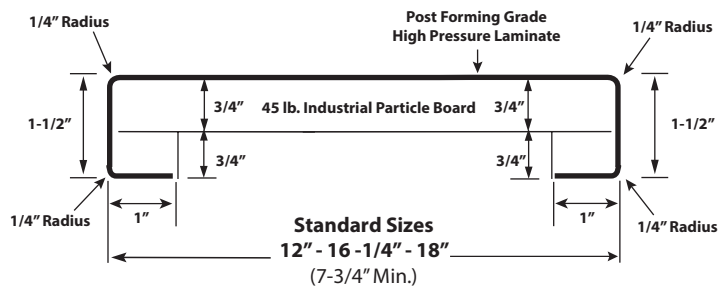



Prices Are For 8, 10, & 12' Lengths | Order Minimums Do Apply

KITCHEN TOPS

(per linear foot)

25-1/4" Deep w/ 3" Splash - Monarch Only	\$22.20
25-1/2" Deep w/ 3" Splash	\$22.20
25" Deep w/ 4" Splash	\$28.26
25-1/2" Deep w/ 4" Splash	\$28.26

VANITY TOPS

22-1/2" Deep w/ 3" Splash	\$22.20
---------------------------------	---------

SINGLE EDGE TOPS

2" to 26" Deep..... color upcharge use Kit. / Van. group	\$22.20
26-1/8" to 34-3/4" color upcharge use Island group (27-1/4" - 45")	\$31.48
34-7/8" to 44" color upcharge use Island group (27-1/4" - 45")	\$43.12
44-1/8" to 49" color upcharge use Island group (over 45").....	\$50.72

ISLAND TOPS

12", 16-1/4" AND 18"	\$22.20
27-1/8".....	\$28.26
32", 35-3/4"	\$31.48

SPECIAL DEPTH ISLANDS

For large quantities in special sizes - call for pricing

7-3/4" to 27" (8', 10', 12' Only).... color upcharge use Kit. / Van. group.....	\$30.32
27-1/4" to 35-1/2" color upcharge use Island group (27-1/4" - 45")	\$40.02
36" to 45"* color upcharge use Island group (27-1/4" - 45")	\$43.12
45-1/4" to 50"* color upcharge use Island group (over 45").....	\$50.72

* Backer is required for tops that exceed 36" in width when temperature and humidity levels are elevated. Orders requested without backer will void warranty coverage.

SPECIAL DEPTH &/OR SPLASH HEIGHT (5-5/8" HIGH MAX.)

~Overall top depth plus splash height~ (8', 10' or 12' ONLY)

Equal to or less than 28-1/2".....color upcharge use Kit. / Van. group	\$30.44
28 -1/2" up to 37".....color upcharge use Island group (27-1/4" - 45")	\$40.14
Greater than 37-1/8" up to 51"color upcharge use Island group (over 45").....	\$45.64

ADDITIONAL CHARGES

(per linear foot)

Island Tops With Scribe.....	ADD	\$5.50
------------------------------	-----------	--------

UPCHARGES

	KIT. / VAN.	ISLANDS	ISLANDS	
	(up to 27-1/8" Islands)	(27-1/4" to 45")	(over 45")	
Group 1.....	ADD	\$1.60	\$2.88.....	\$3.20
Group 2.....	ADD	\$3.40	\$6.12	\$6.80
Group 3.....	ADD	\$4.42	\$7.96	\$8.84
Group 4.....	ADD	\$10.30	\$18.54.....	\$20.60

TOPS W/ BACKER

Up to 30" Deep	ADD	\$6.24
30-1/8" - 45".....	ADD	\$8.35
For Tops over 45" deep	ADD	\$10.96

Non-stock rush orders are subject to a minimum charge\$114.00



Not available with certain colors and finishes.

NO BACKER ON FRONT BUILD DOWN, PARTICLE BOARD SCRIBE STICK

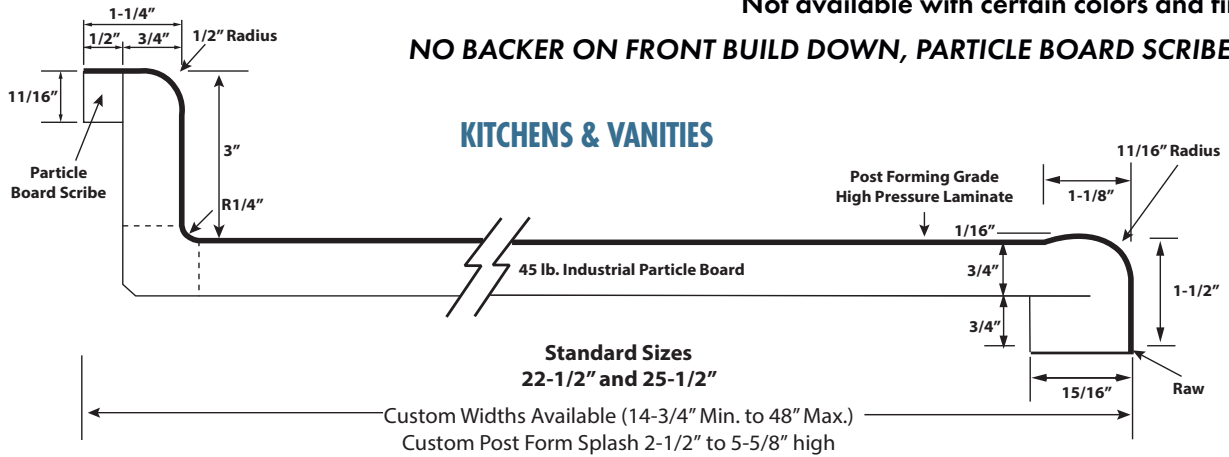

ISLANDS

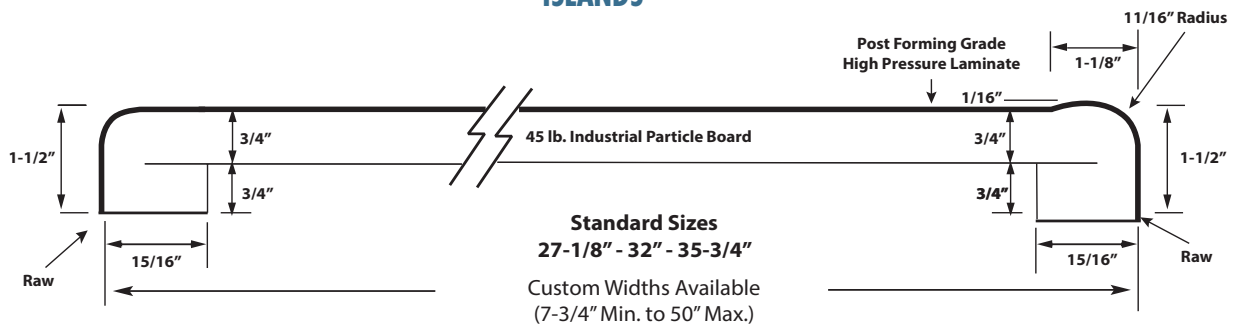

Backer is required for tops that exceed 36" in width when temperature and humidity levels are elevated.

Orders requested without backer will void warranty coverage.

SINGLE EDGE COUNTERTOPS

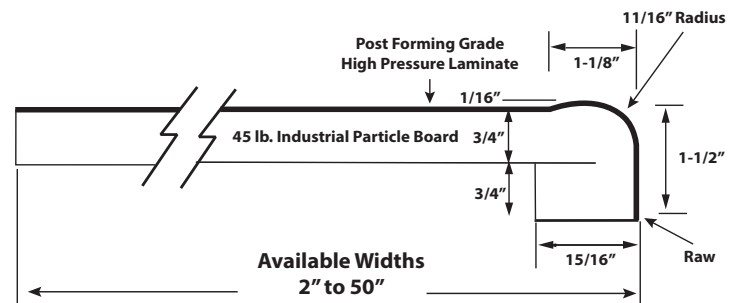

NARROW ISLANDS

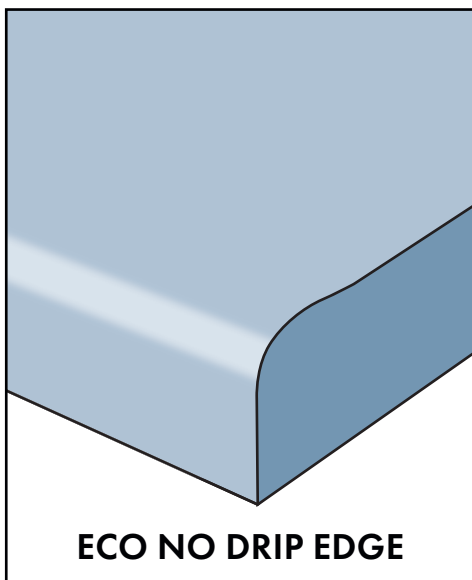
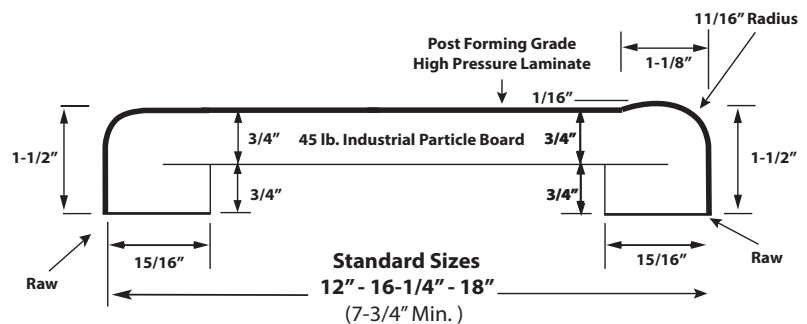

ECO NO DRIP EDGE

Prices Are For 8, 10, & 12' Lengths | Order Minimums Do Apply

KITCHEN TOPS

(per linear foot)

25-1/2" Deep w/ 3" Splash	\$18.20
25" Deep w/ 4" Splash	\$18.20
25-1/4" Deep w/ 3-3/4" Splash	\$18.20
25-1/2" Deep w/ 4" Splash	\$25.00

VANITY TOPS

22-1/2" Deep w/ 3" Splash	\$18.20
---------------------------------	---------

SINGLE EDGE TOPS

2" to 26" Deep	color upcharge use Kit. / Van. group	\$18.20
26-1/8" to 34-3/4"	color upcharge use Island group (27-1/4" - 45")	\$27.48
34-7/8" to 44"	color upcharge use Island group (27-1/4" - 45")	\$39.12
44-1/8" to 49"	color upcharge use Island group (over 45")	\$46.72

ISLAND TOPS

12", 16-1/4" AND 18"	Islands have No Drip Edge on one side only.....	\$18.20
27-1/8"	Islands have No Drip Edge on one side only.....	\$18.20
32", 35-3/4"	Islands have No Drip Edge on one side only.....	\$27.48

SPECIAL DEPTH ISLANDS

For large quantities in special sizes - call for pricing

7-3/4" to 27"	Islands have No Drip Edge on one side only.....	\$26.32
27-1/4" to 35-1/2"	Islands have No Drip Edge on one side only.....	\$36.02
36" to 45"*	Islands have No Drip Edge on one side only.....	\$39.12
45-1/4" to 50"*	Islands have No Drip Edge on one side only.....	\$46.72

* Backer is required for tops that exceed 36" in width when temperature and humidity levels are elevated. Orders requested without backer will void warranty coverage.

SPECIAL DEPTH &/OR SPLASH HEIGHT (5-5/8" HIGH MAX.)

~Overall top depth plus splash height~ (8', 10' or 12' ONLY)

Equal to or less than 28-1/2"	color upcharge use Kit. / Van. group	\$26.44
28 -1/2" up to 37"	color upcharge use Island group (27-1/4" - 45")	\$36.14
Greater than 37-1/8" up to 51"	color upcharge use Island group (over 45")	\$41.64

ADDITIONAL CHARGES

(per linear foot)

Island Tops With Scribe.....	ADD	\$5.50
------------------------------	-----------	--------

UPCHARGES

	KIT. / VAN.	ISLANDS	ISLANDS	
	(up to 27-1/8" Islands)	(27-1/4" to 45")	(over 45")	
Group 1	ADD	\$1.60	\$2.88.....	\$3.20
Group 2.....	ADD	\$3.40	\$6.12	\$6.80
Group 3.....	ADD	\$4.42	\$7.96.....	\$8.84
Group 4.....	ADD	\$10.30.....	\$18.54.....	\$20.60

TOPS W/ BACKER

Up to 30" Deep	ADD	\$6.24
30-1/8" - 45"	ADD	\$8.35
For Tops over 45" deep	ADD	\$10.96

Non-stock rush orders are subject to a minimum charge\$114.00

SPLASHES

Square Edge End Splash, finished or with loose edging strips	\$27.62
Square edge end splash, with Radiused front bottom corner, Made for D & 180 profile.....	\$43.36
Island end splash (finished both ends).....	\$38.66
Standard Contoured to set on top of top.....	\$35.30
Special Depth Contoured to set on top of top..... (Call for Multi Unit pricing)	\$59.26
Poly Applied to Counter Tops	(Per lineal foot)
	\$1.60
Seam fill (per tube)	\$15.26
Seam fill Solvent (1/2 pint can).....	\$36.80
Seam fill Solvent (Quart can)	\$73.50
3/4" Particle Board (stock sizes only).....	Priced per square foot
	\$2.40
1-1/8" Particle Board (60 x 96 & 30 x 144).....	Priced per square foot.....
	\$3.14
Counter tops fabricated with	
Sky Blend - particle brd	
Ultra Low Emitting Formaldehyde (ULEF)	
Moisture Resistant (MR10).....	(Per Square Foot)
	\$2.80
Counter tops fabricated with;	
Med Ex - MDF	
Moisture Resistant (MR50) (ULEF).....	(Per Square Foot)
	\$4.68
Counter tops fabricated with;	
Plywood.....	(Per Square Foot)
	\$5.78
Padding Strips (loose) 3/4"x 2-9/16" x 8' , 10' or 12'	(Per lineal foot)
	\$0.74
MR / ULEF Padding Strips (loose) 3/4"x 2-9/16" x 8' , 10' or 12'.....	(Per lineal foot).....
	\$0.96
Build Down Sticks 3/4" x 1"	(Per lineal foot)
	\$0.38
Build Down Sticks w/Backer 3/4" x 1"	(Per lineal foot).....
	\$0.48
Scribe Sticks 1/2" x 3/4"	(Per lineal foot).....
	\$0.72
Miter Bolts Priced per piece.....	\$0.60
Credit Allowed For Customer Furnished Laminate	
Kitchens, Vanities & 27" Islands.....	(Per lineal foot) net cost, do not use multiplier
	\$2.30
Wide Islands, Per lineal foot.....	\$2.78
Cartoning Charges (does not include shipping charges)	
Laminate	
36" or 48" wide, per carton	\$27.20
60" wide, per carton.....	\$33.80

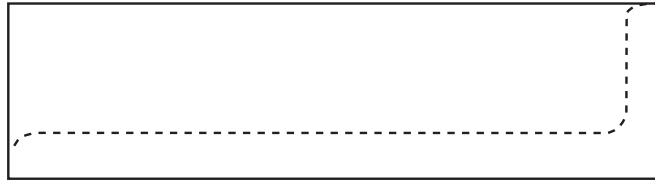
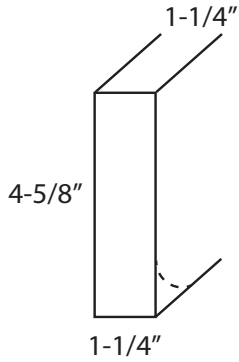

Standard Square Side Splash for All Edge
Note: Screw on splash comes loose and will add 1-1/4" to overall length of top.

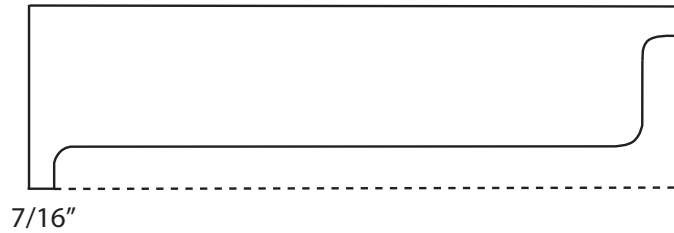
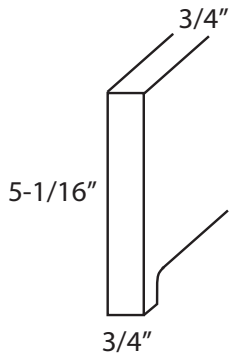

7/16"
Set On Contoured Front & Back for Standard (tri-cove) Side Splash
Standard Sizes: 25-1/2" w/3" B.S.
25-1/4" w/3-3/4" B.S.
25" w/4" B.S.
22-1/2" w/3" B.S.

Specify Length

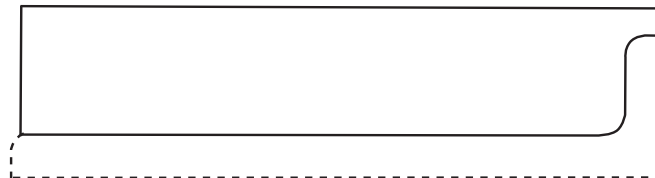
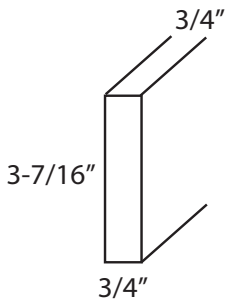

7/16"
Set On Contoured Back Only Side Splash

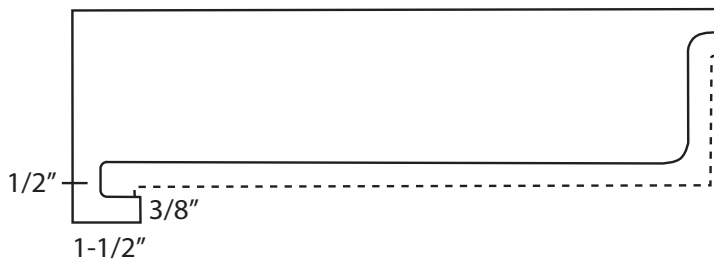
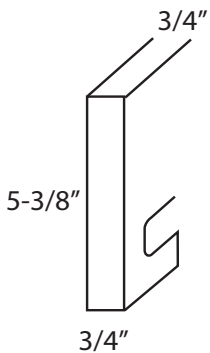

7/16"
Set On Contoured Front & Back for "D" Edge Side Splash
Standard Sizes: 25-1/4" w/3" B.S.
22-1/2" w/3" B.S.

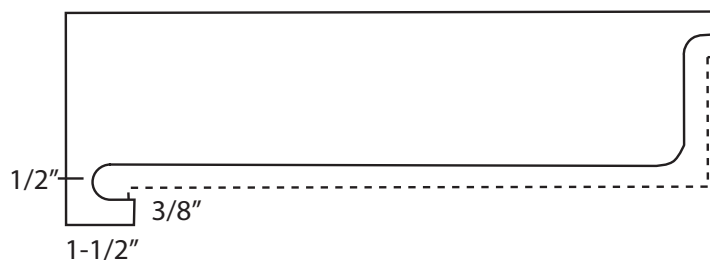
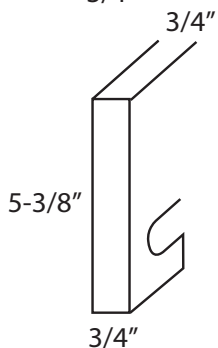

7/16"
Set On Contoured Front & Back for 180° Edge Side Splash
Standard Sizes: 25-1/4" w/3" B.S.
22-1/2" w/3" B.S.